



2021003

Micro Airport



1

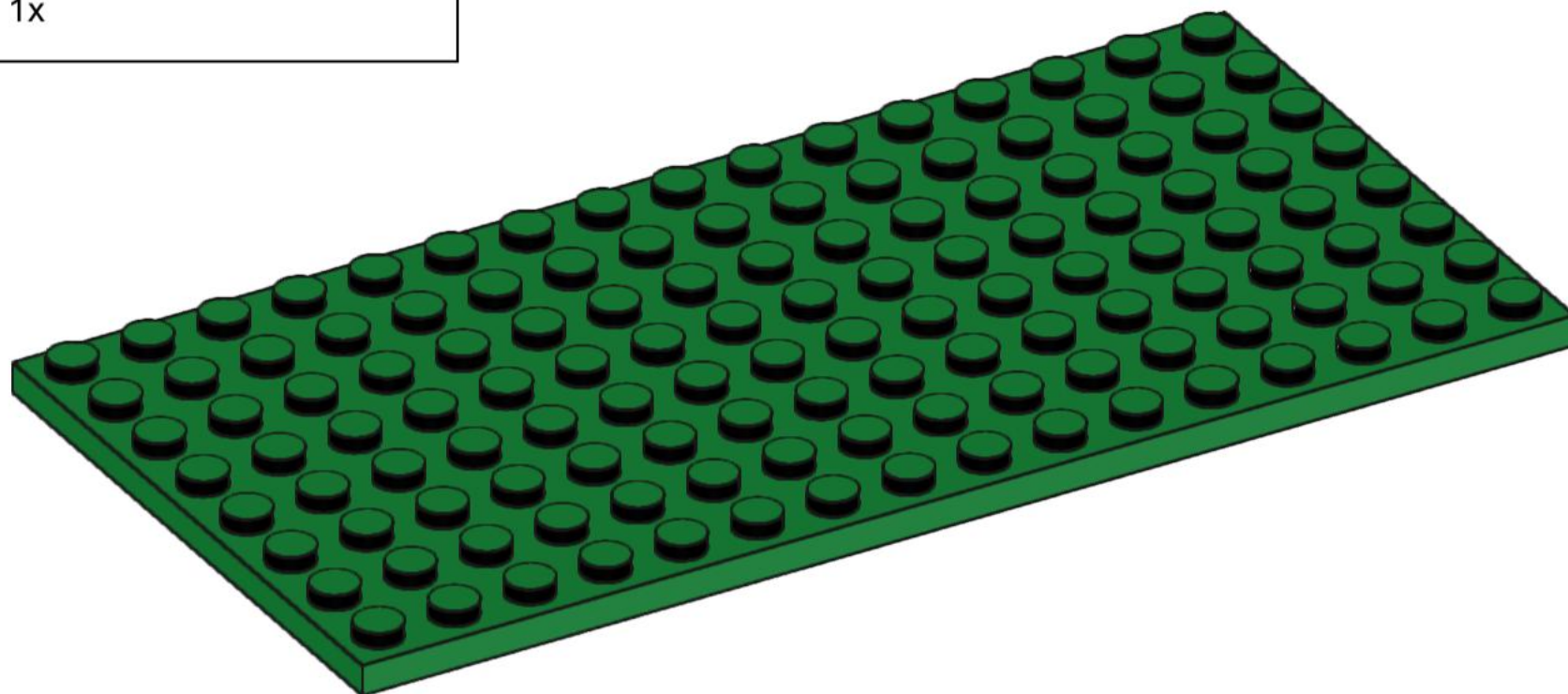
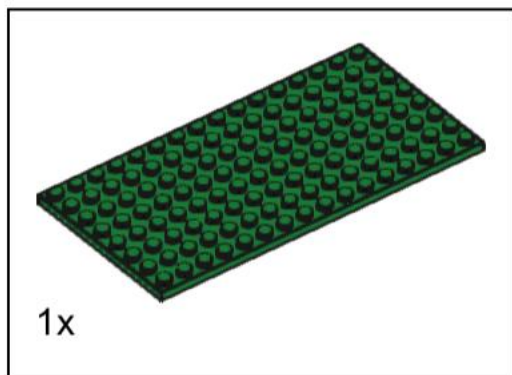

2

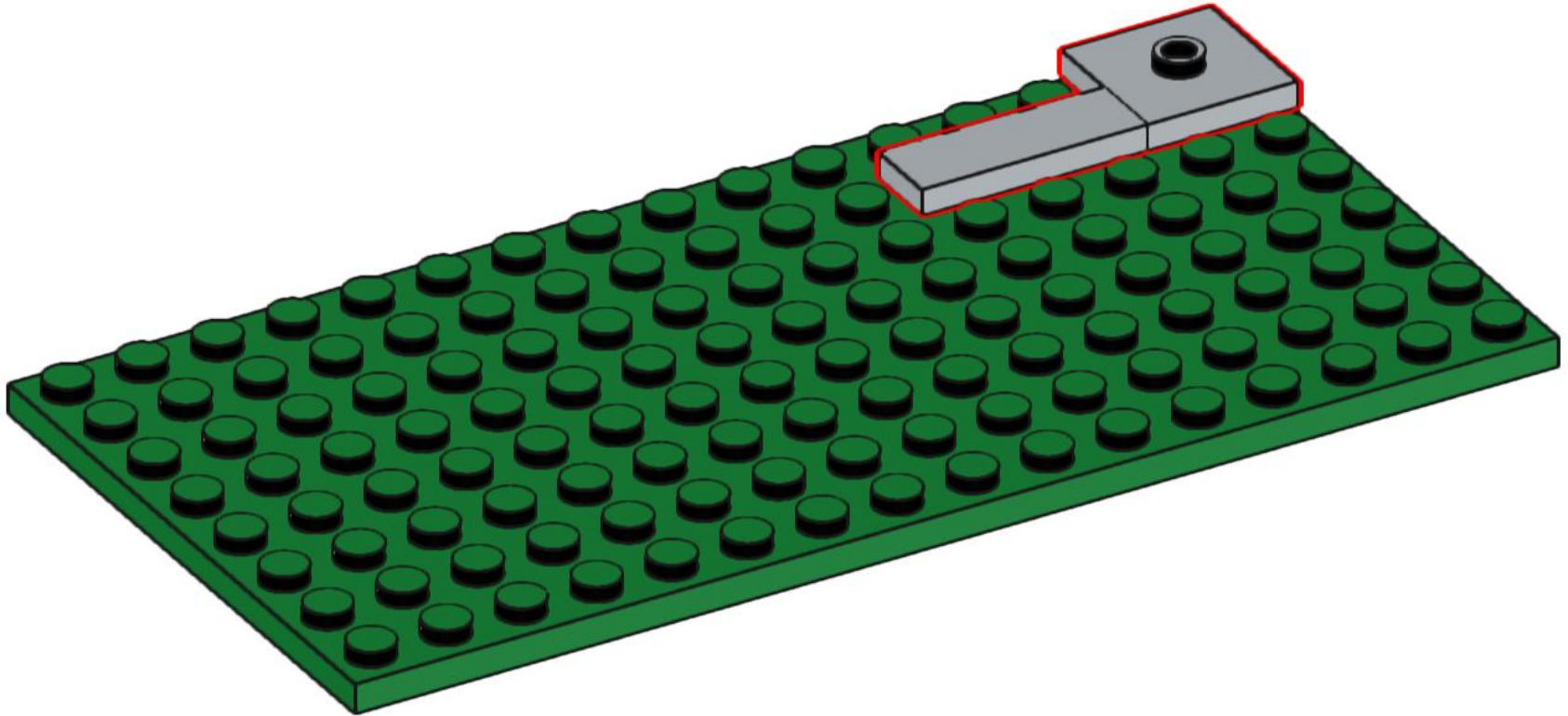
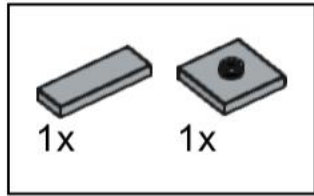

3

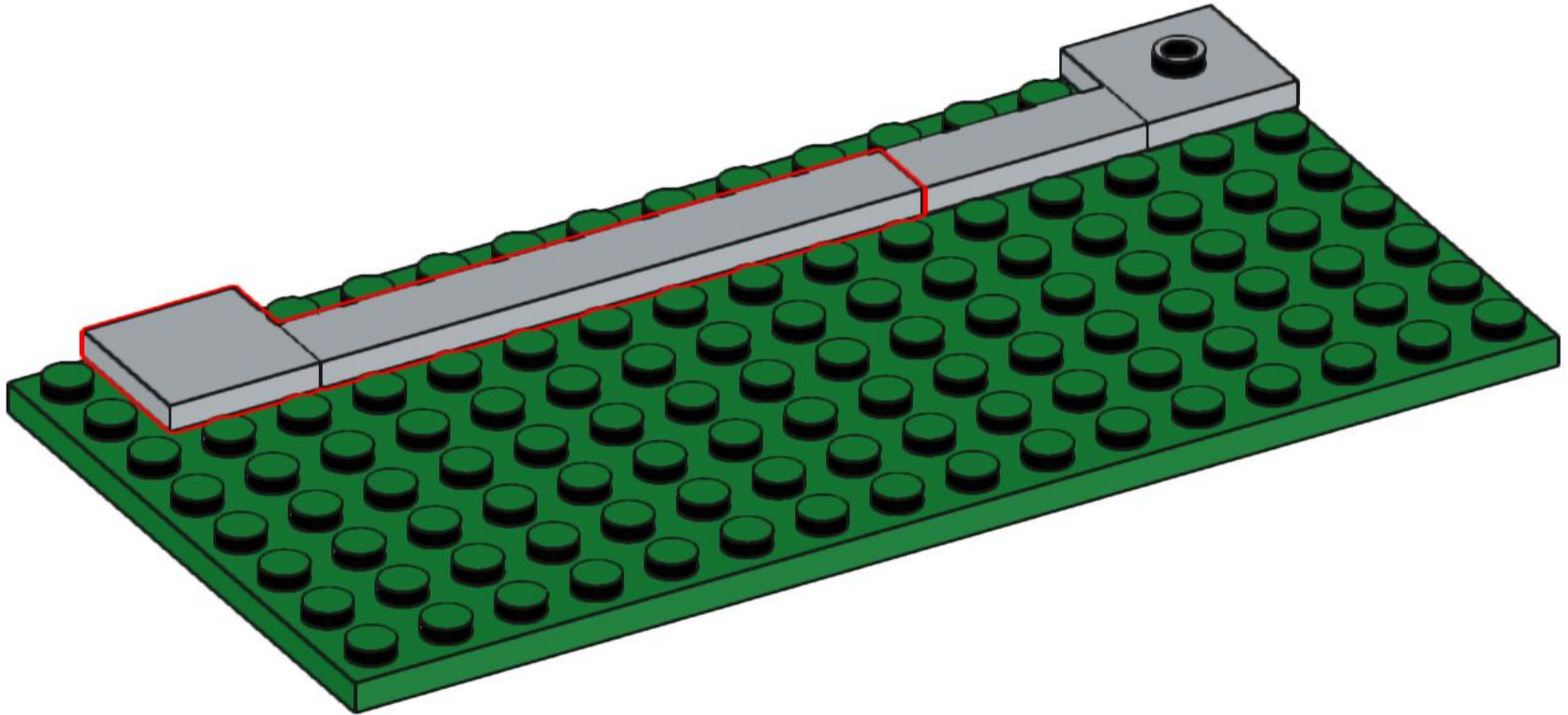
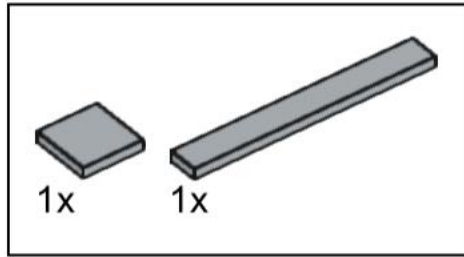

4

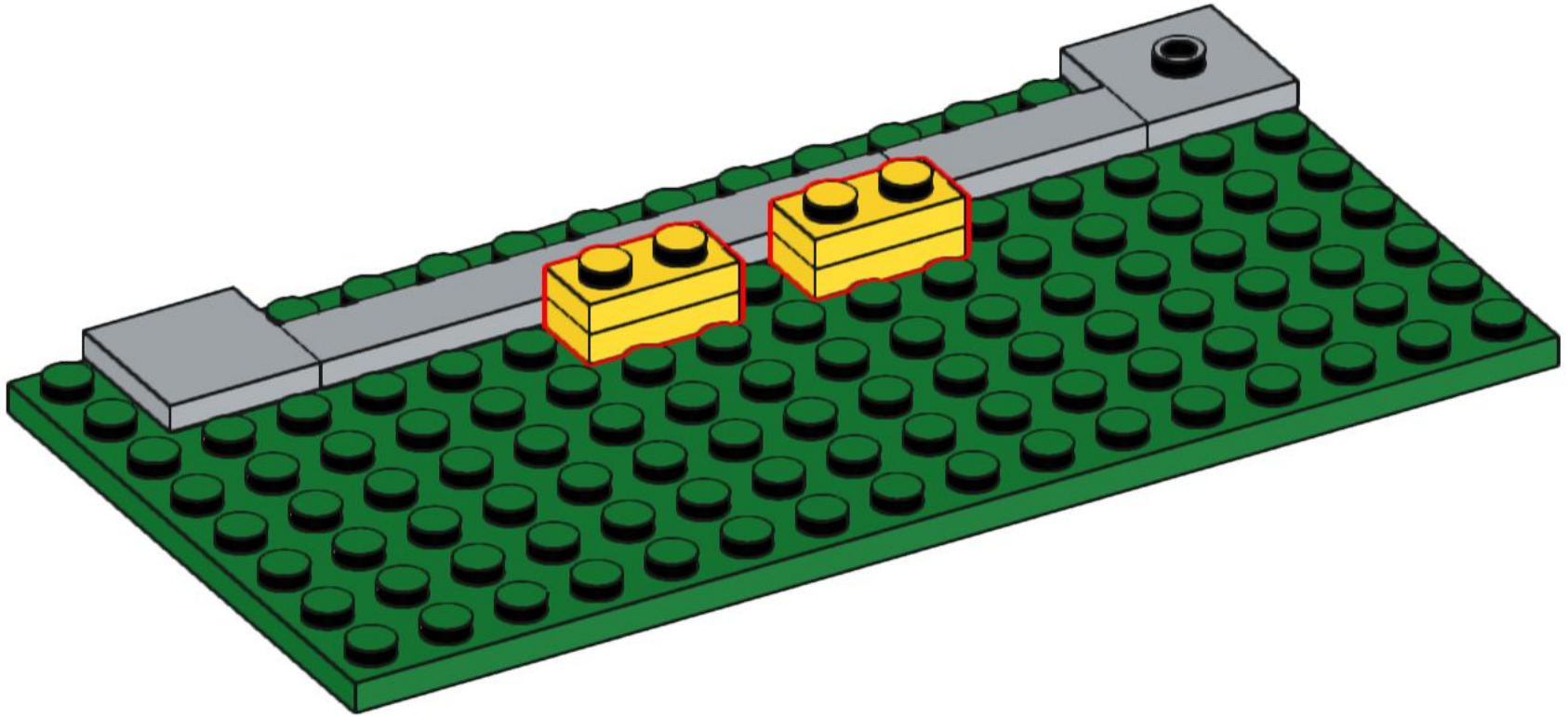
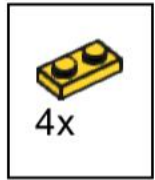

5

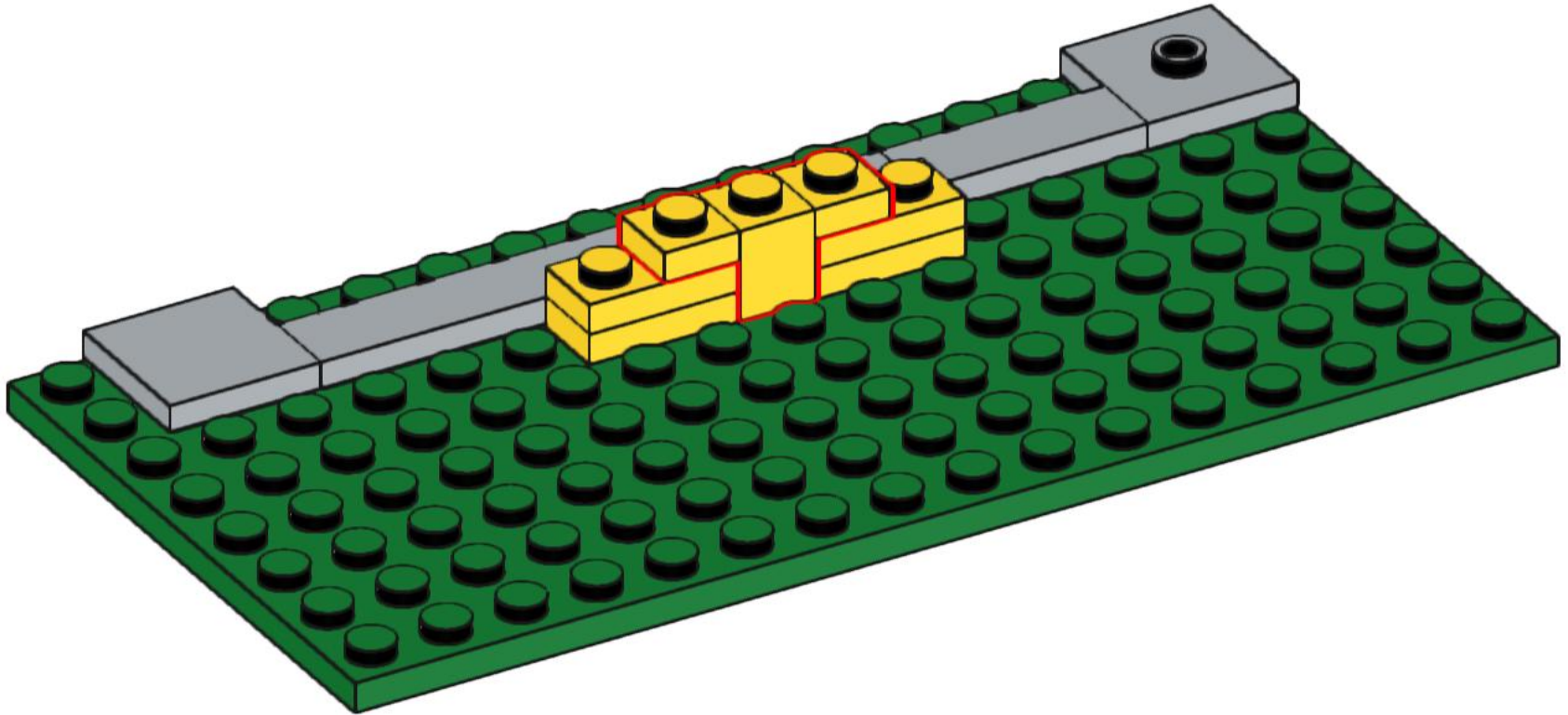
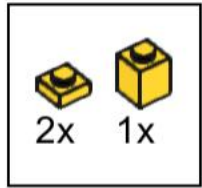

6

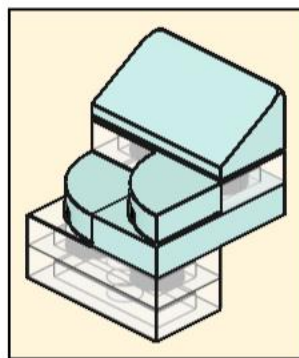
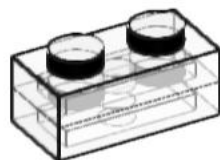
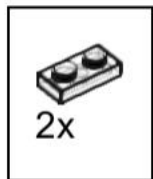

7

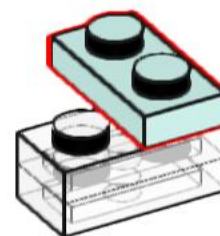
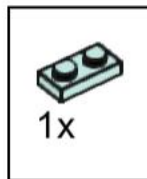

8

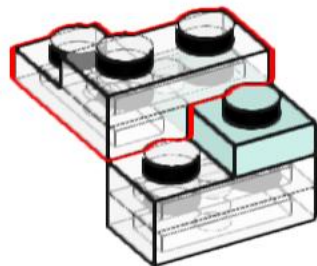
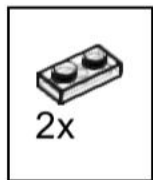

9

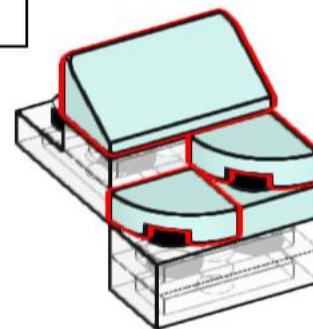
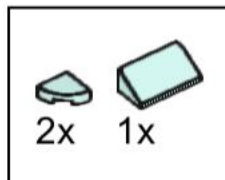

10

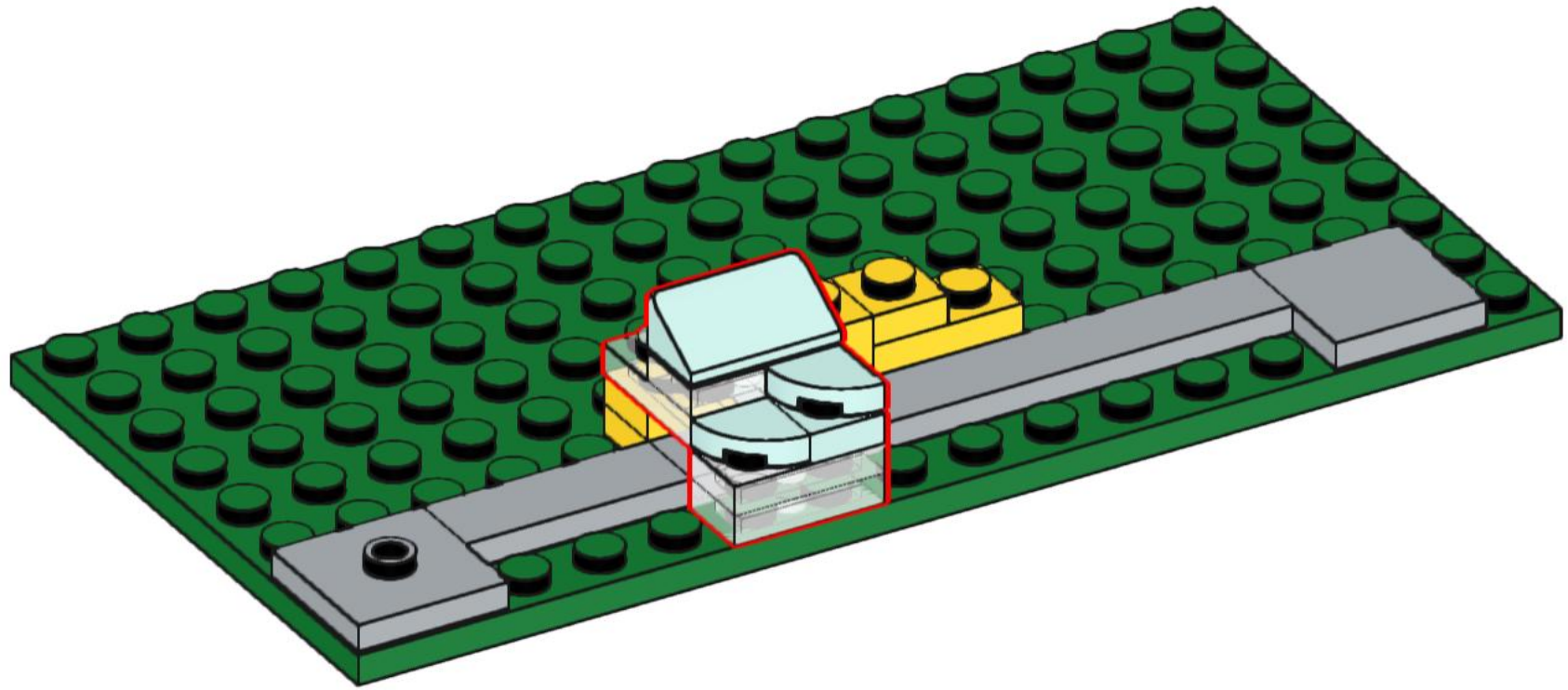

11

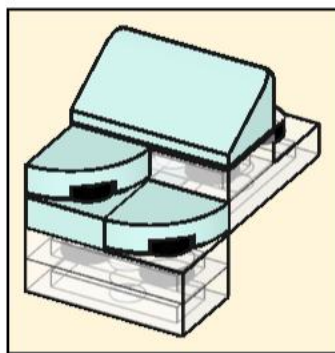
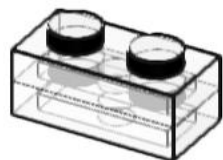
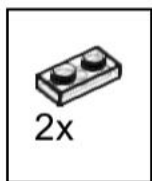

12

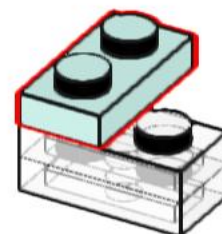
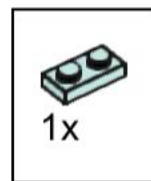

13

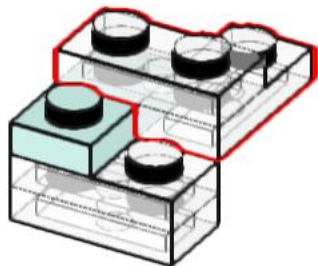
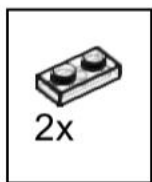

14

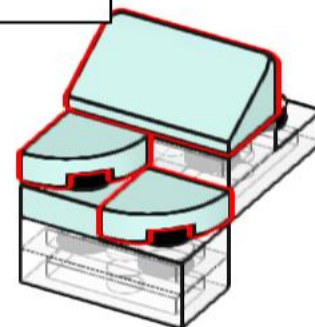
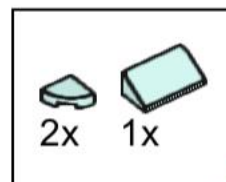

15

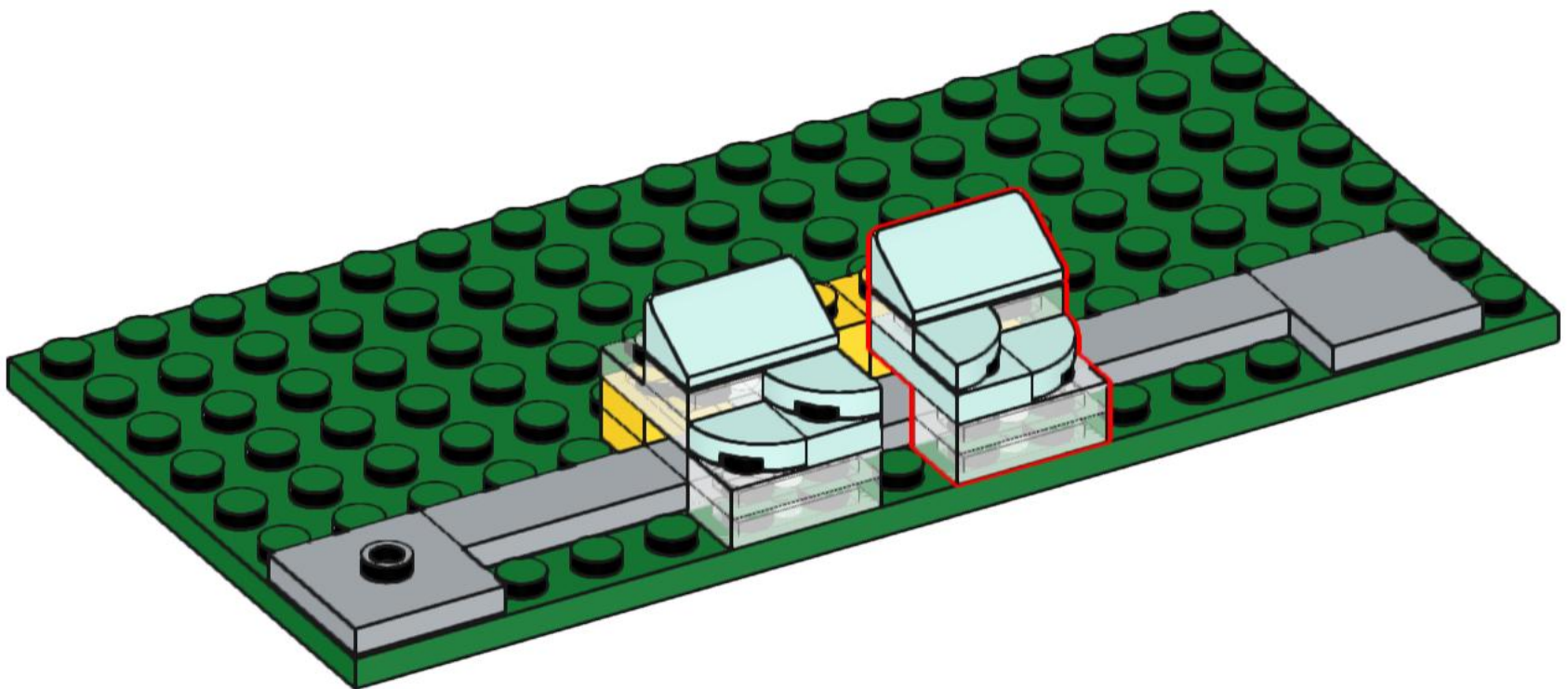

16

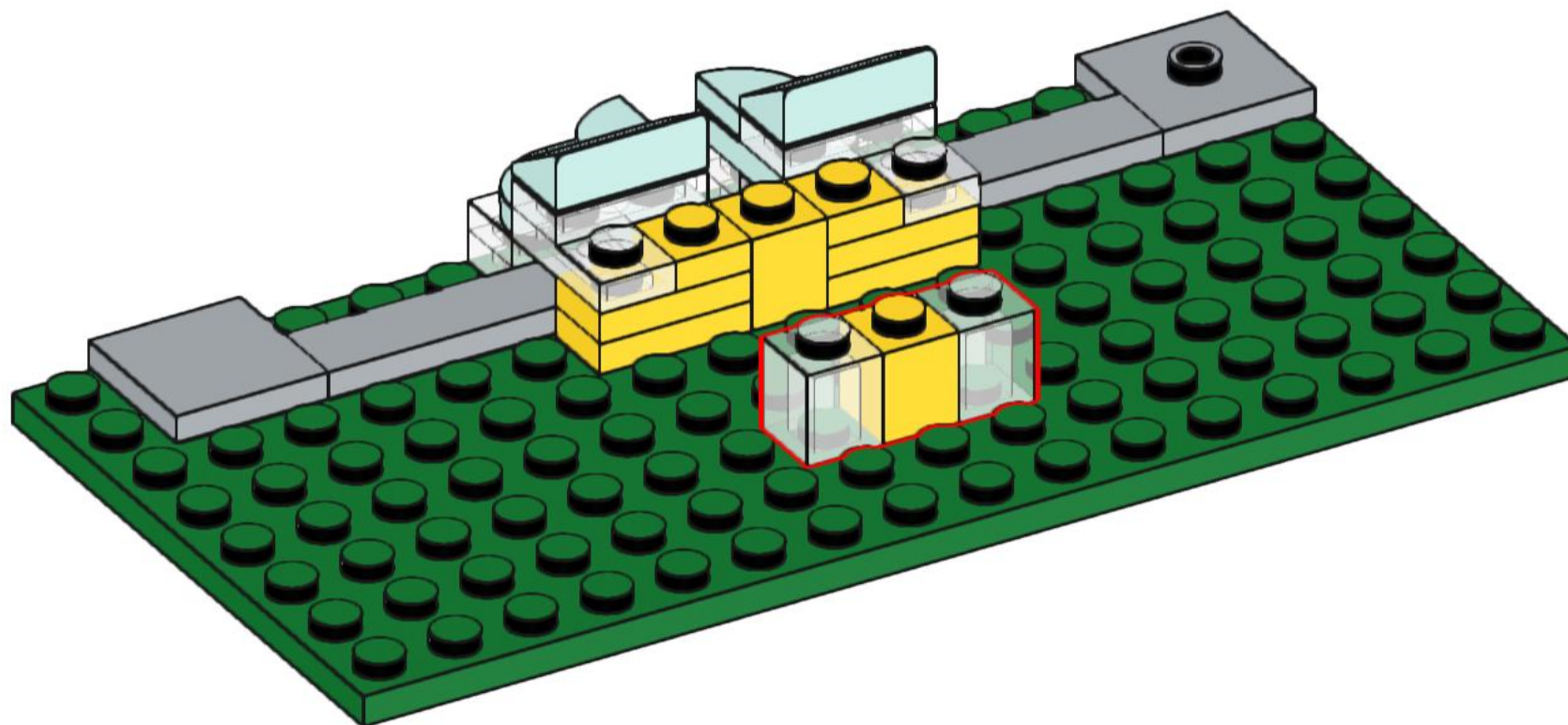
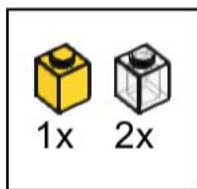

17

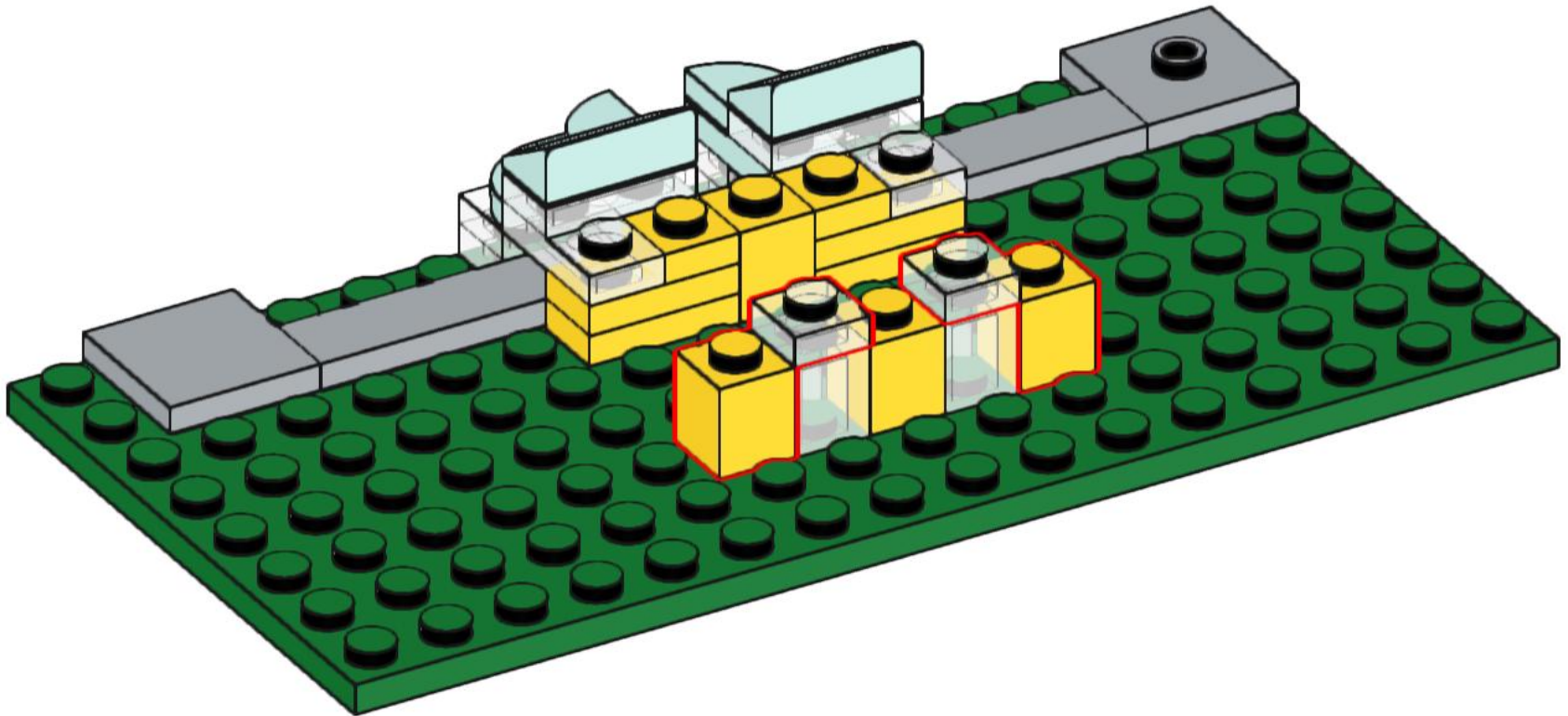
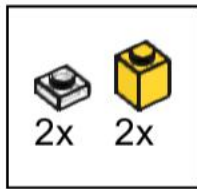

18

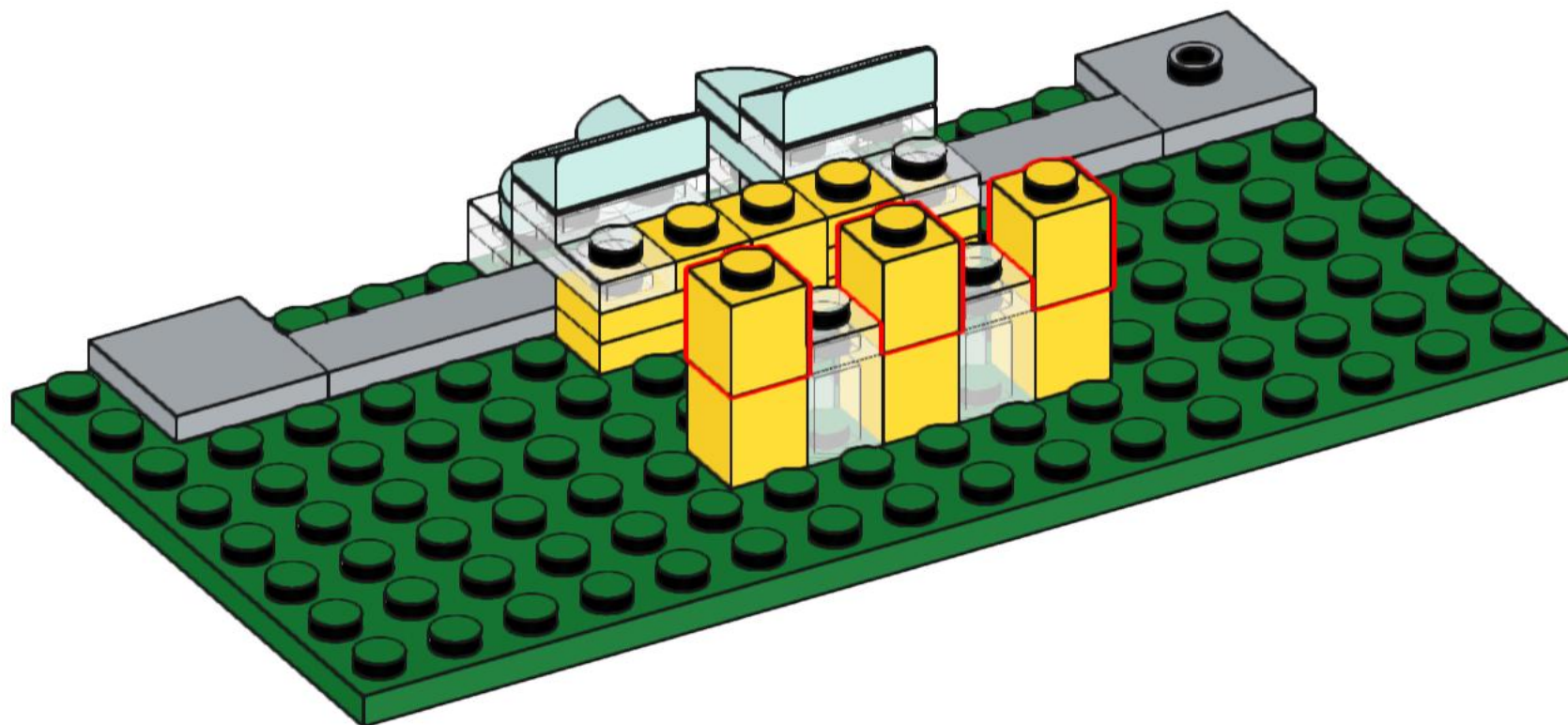
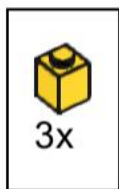

19

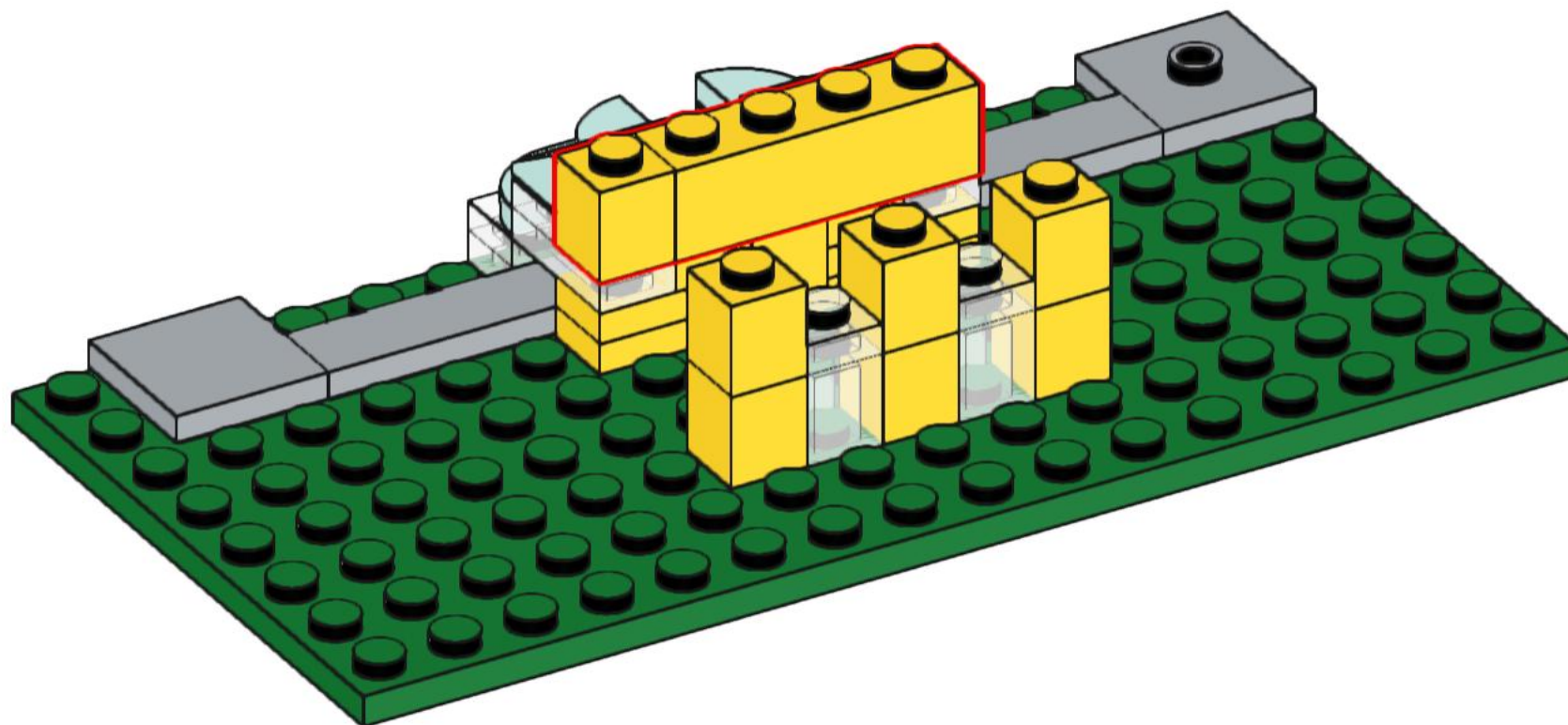
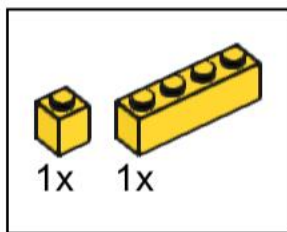

20

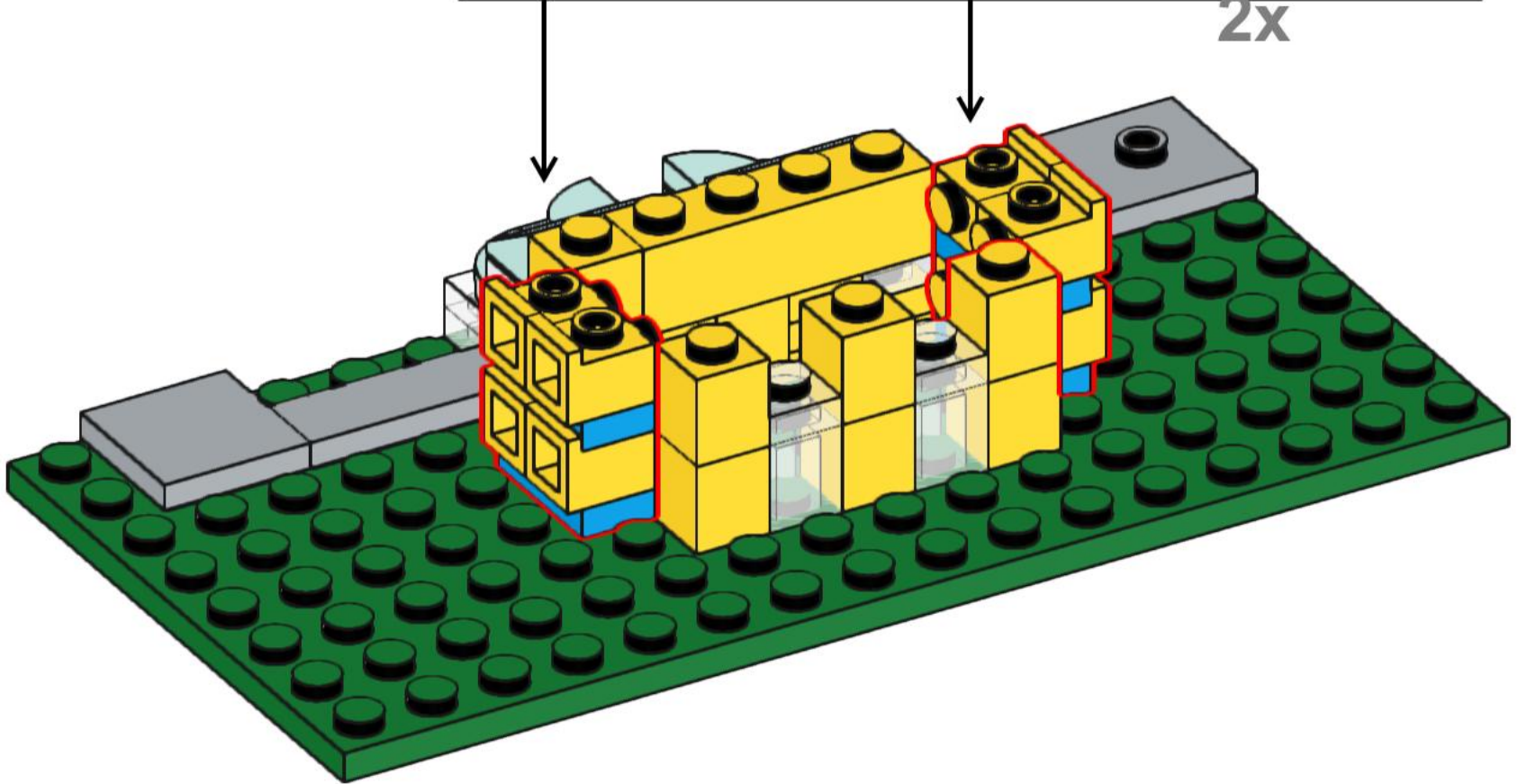
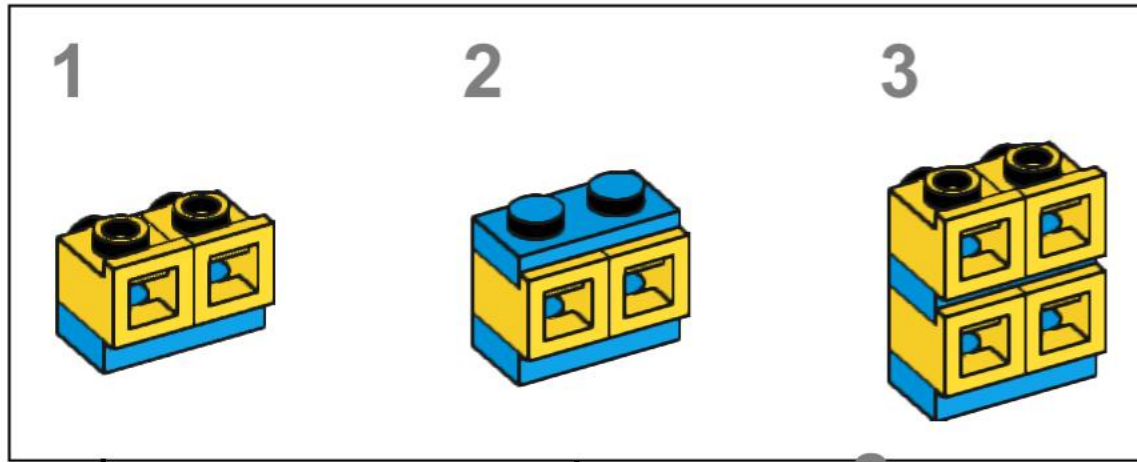
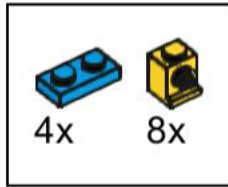

21

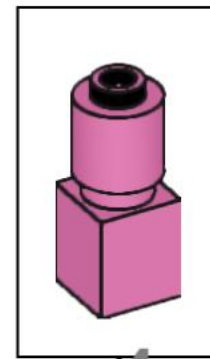
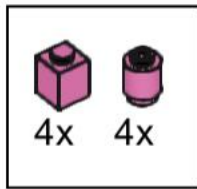

4x

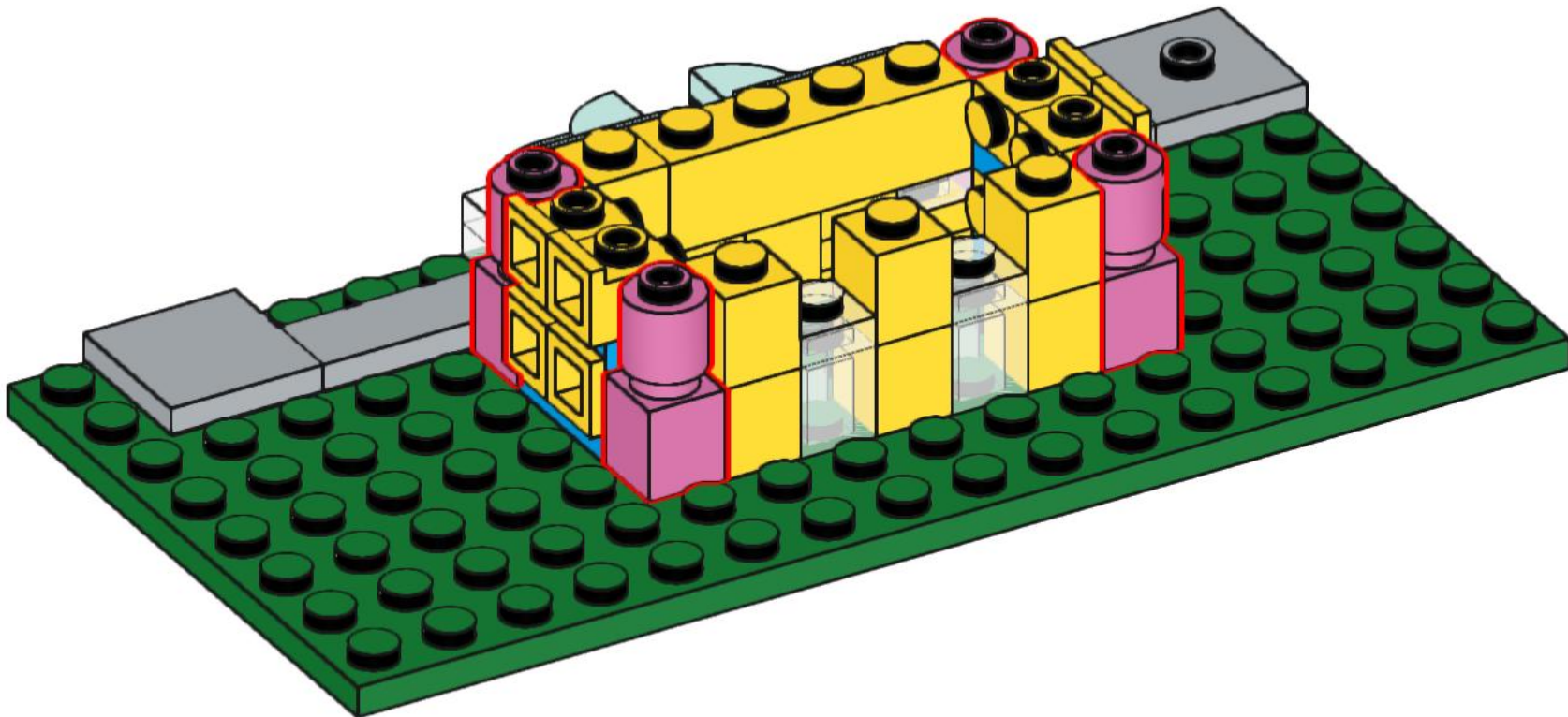

22

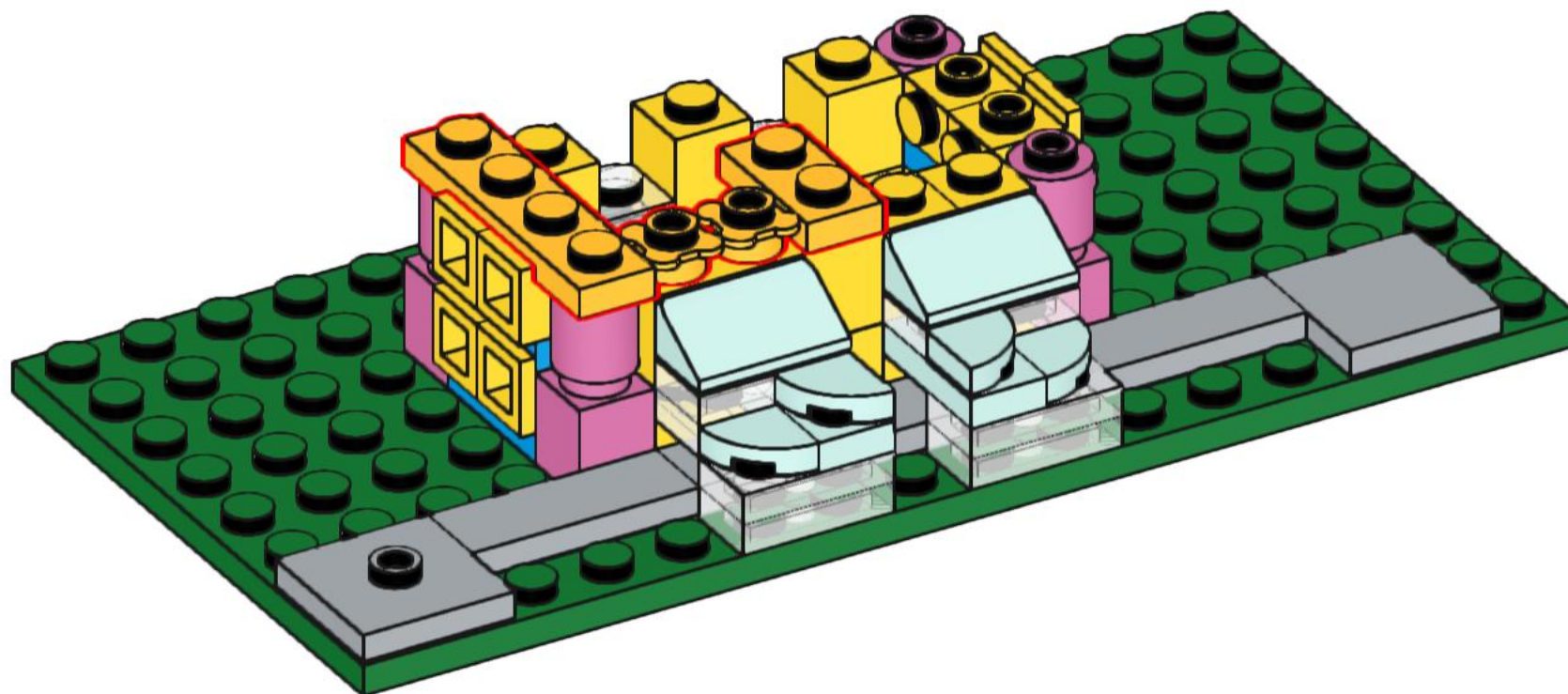
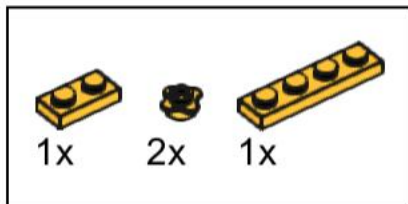

23

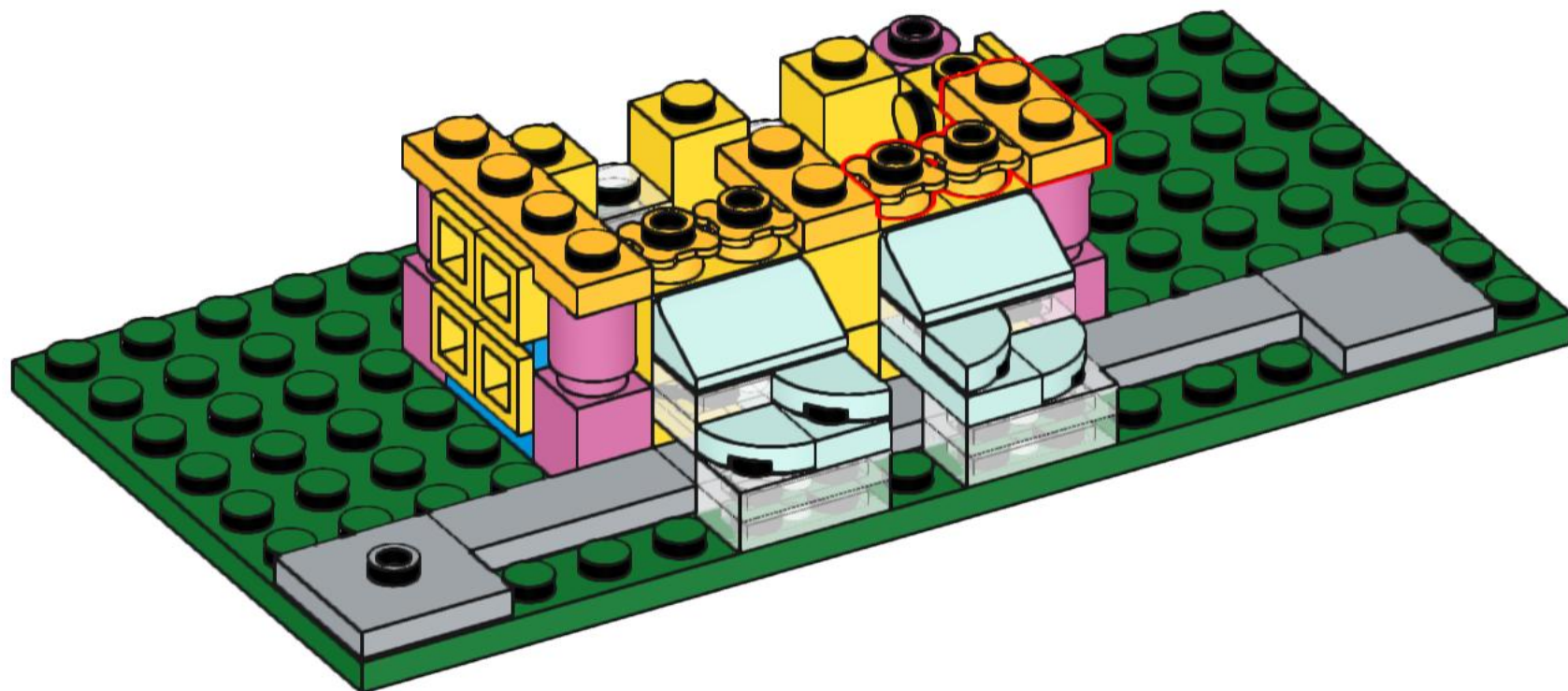
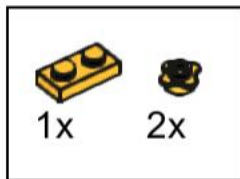

24

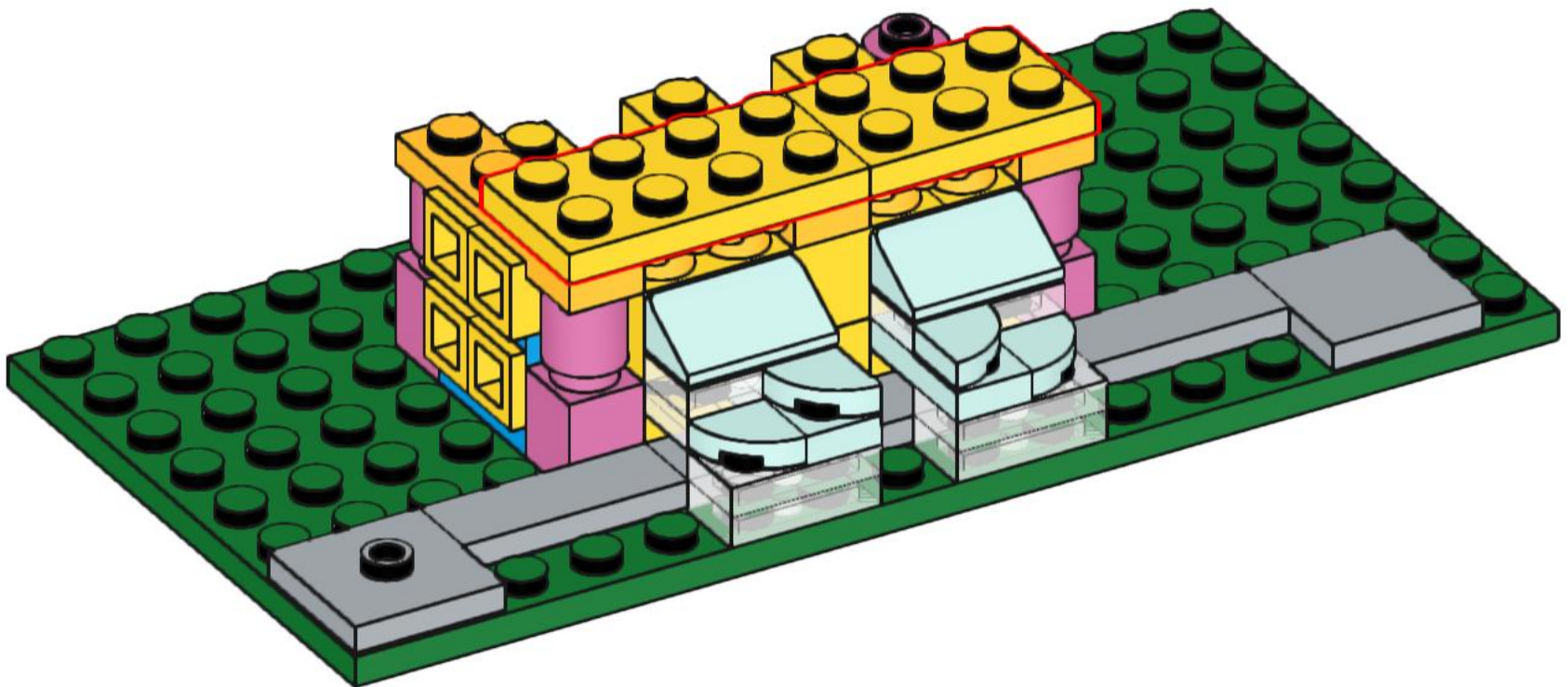
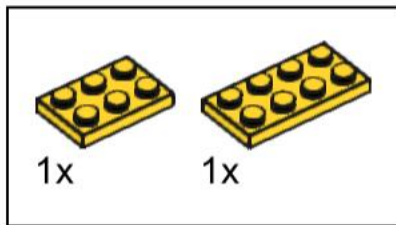

25

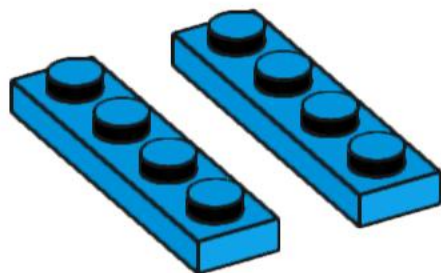
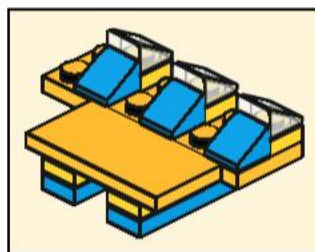
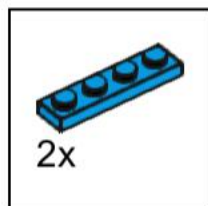

26

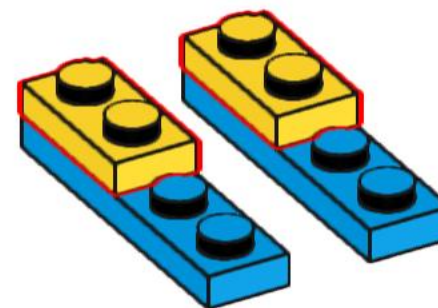
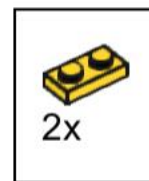

27

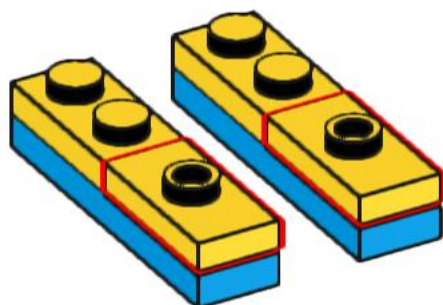
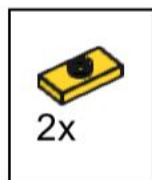

28

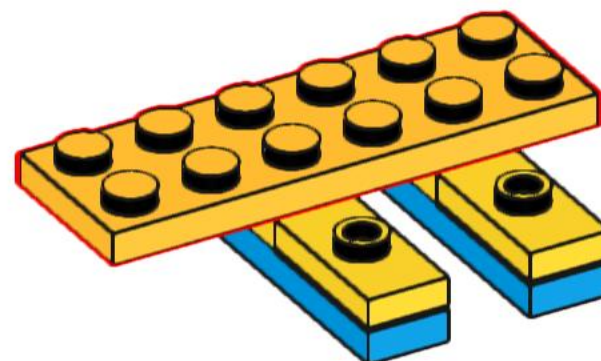
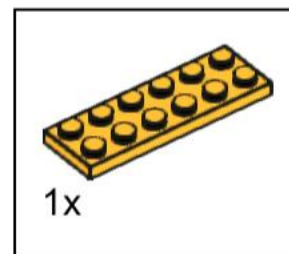

29

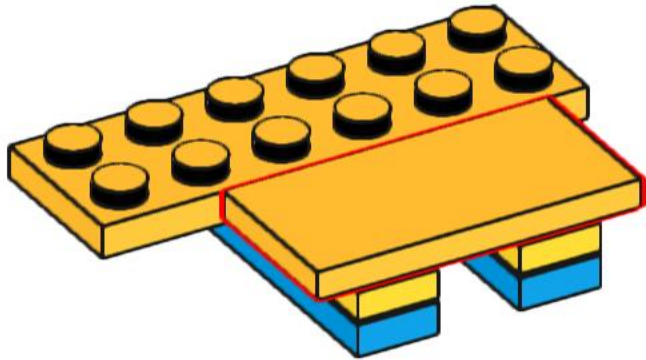
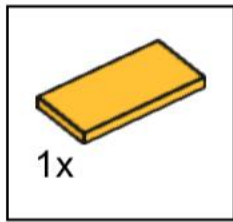

30

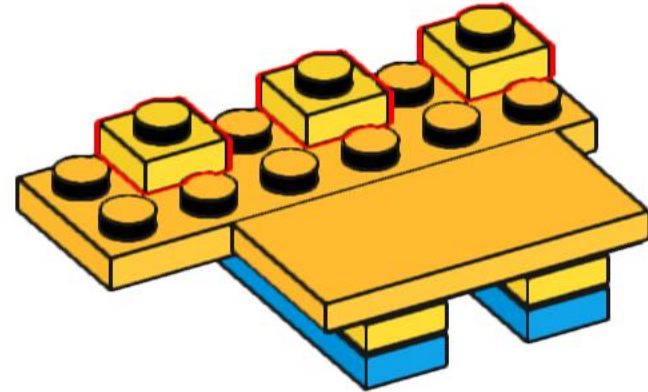
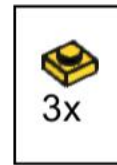

31

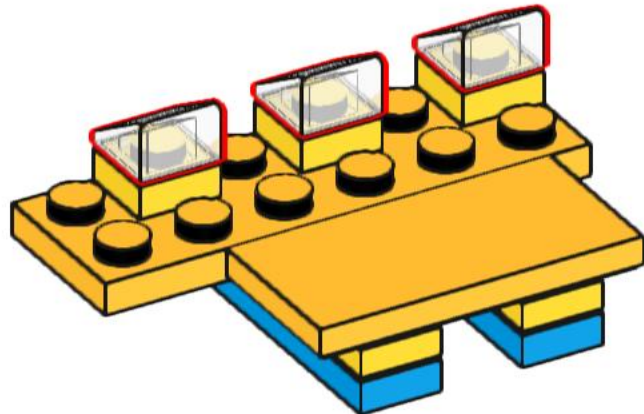

32

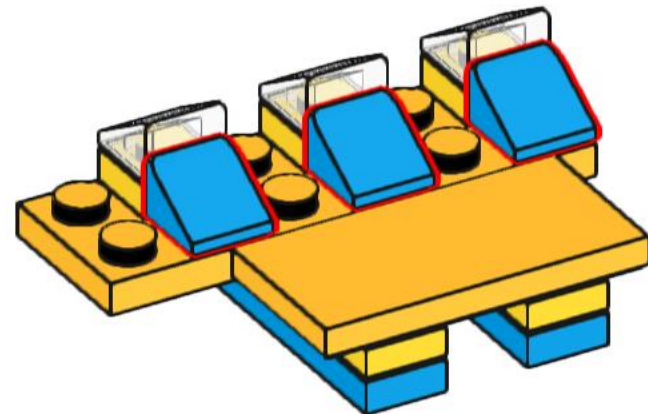
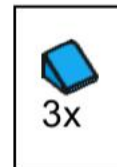

33

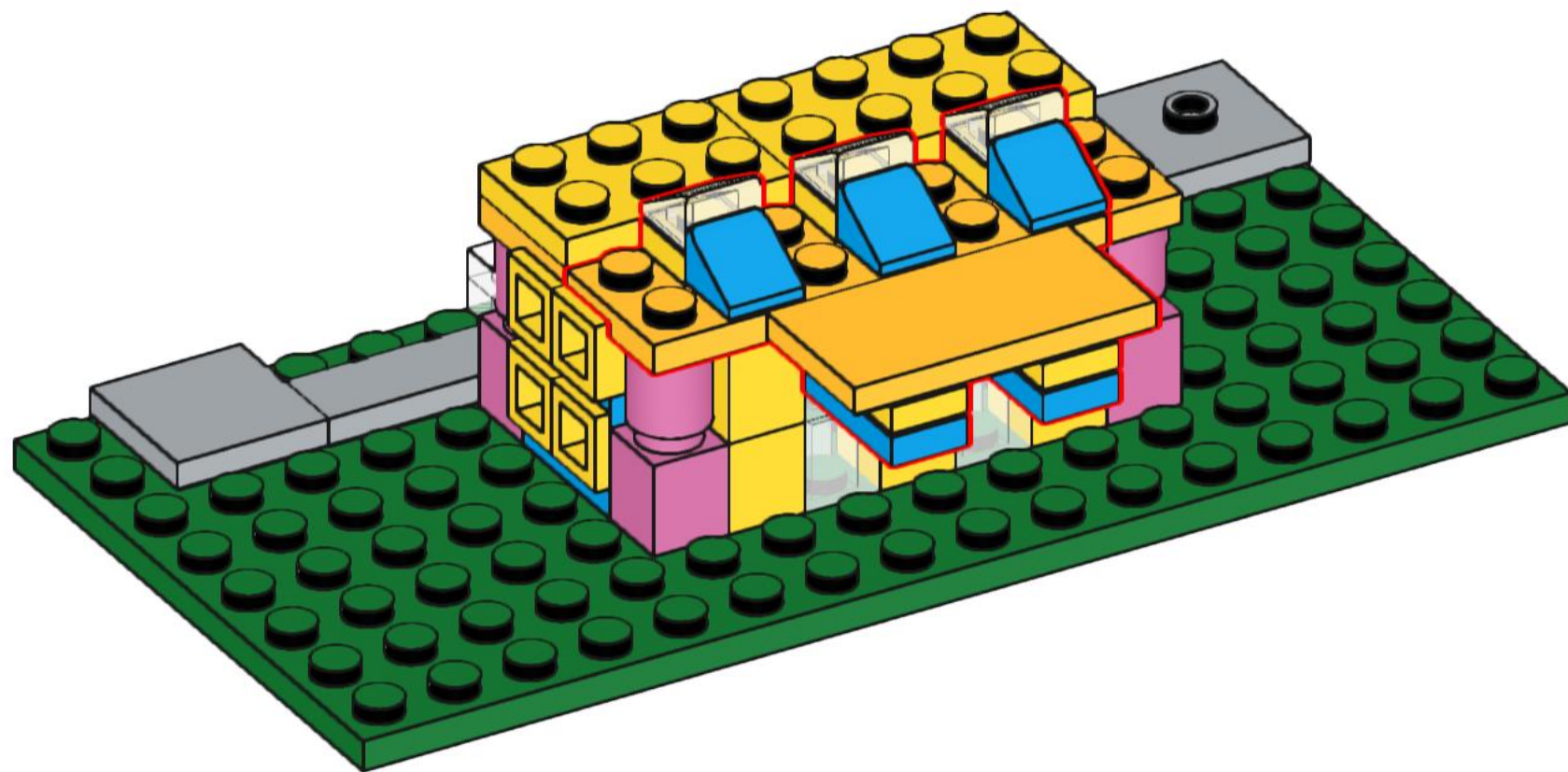

34

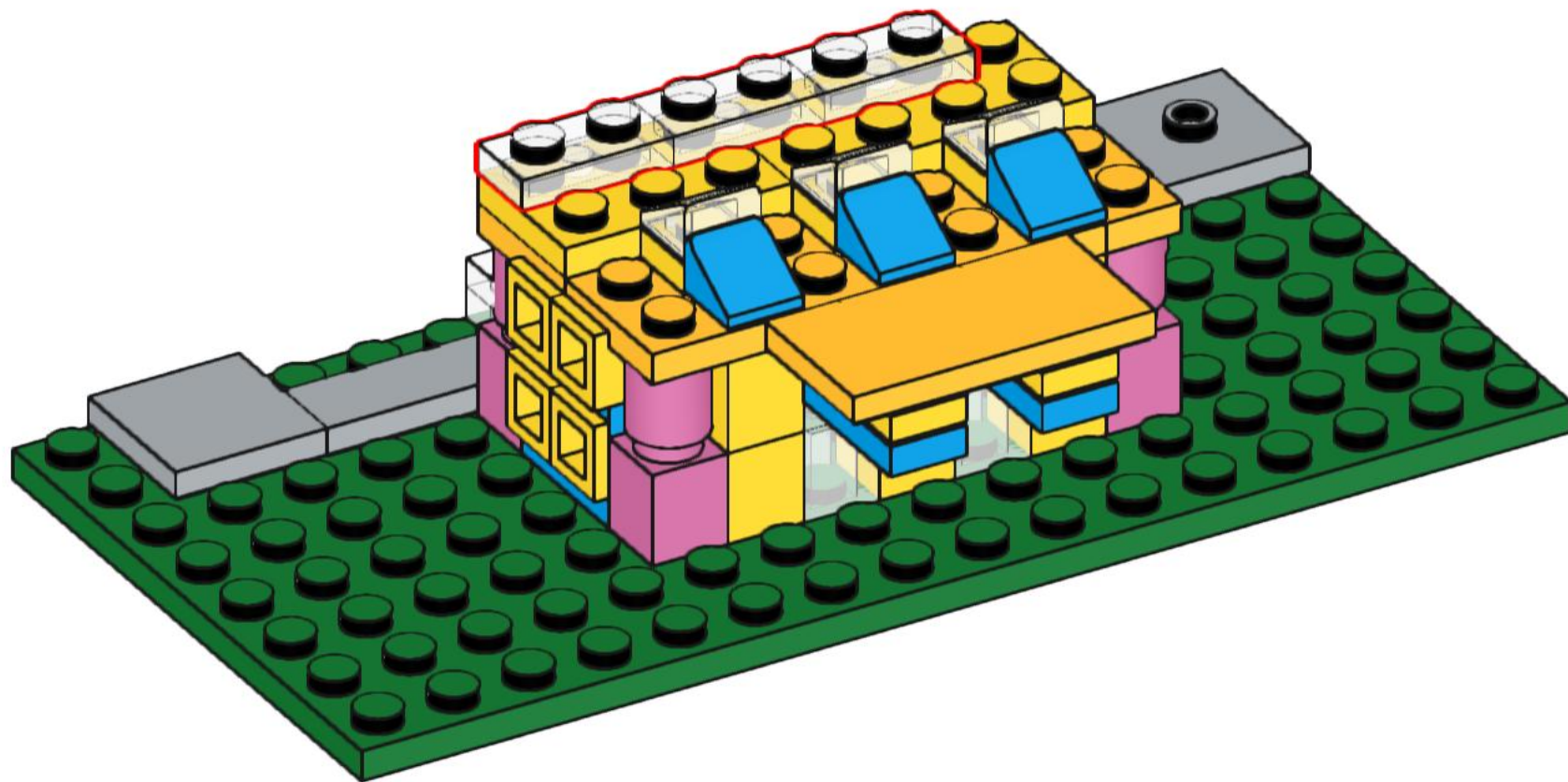
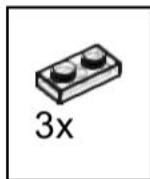

35

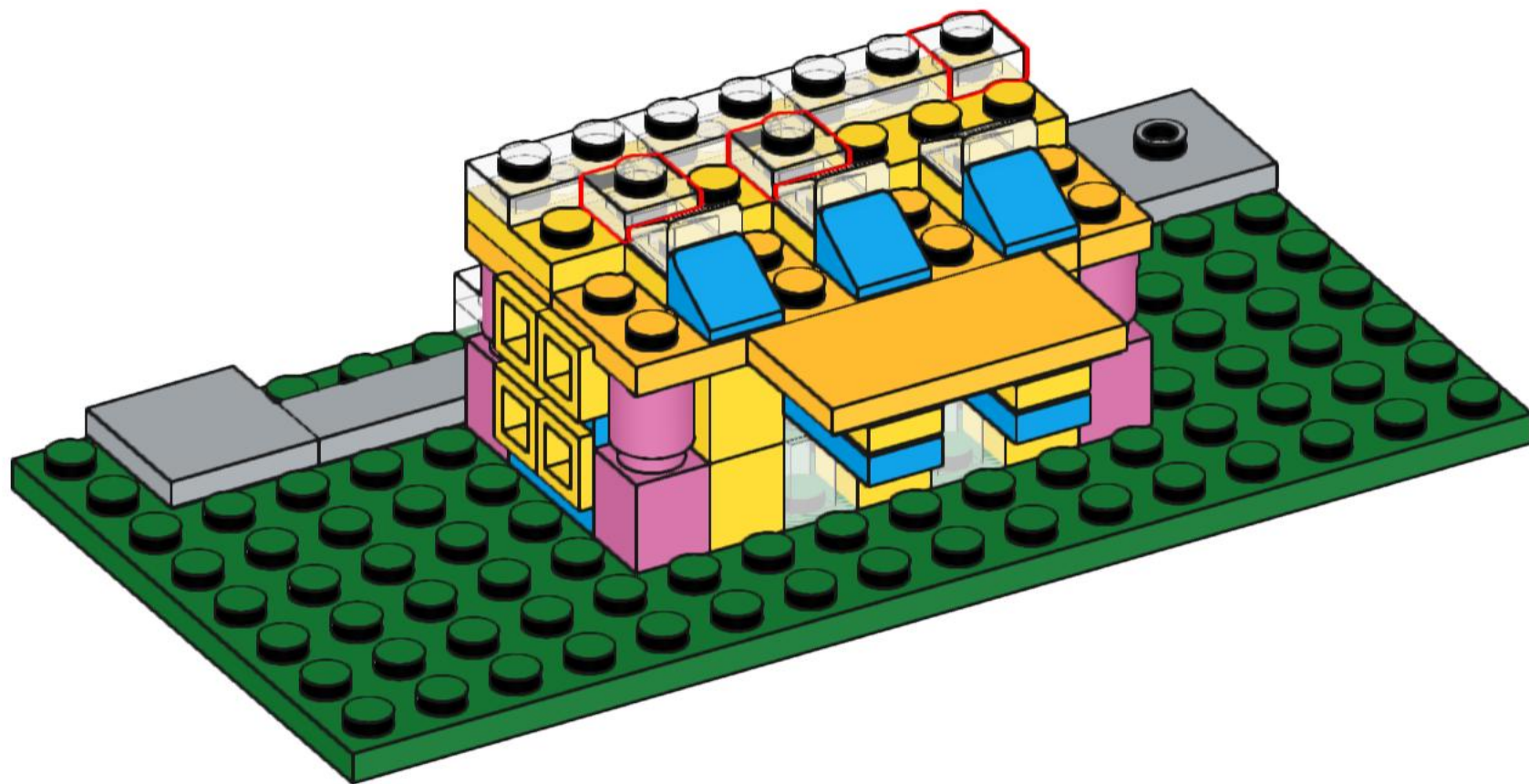

36

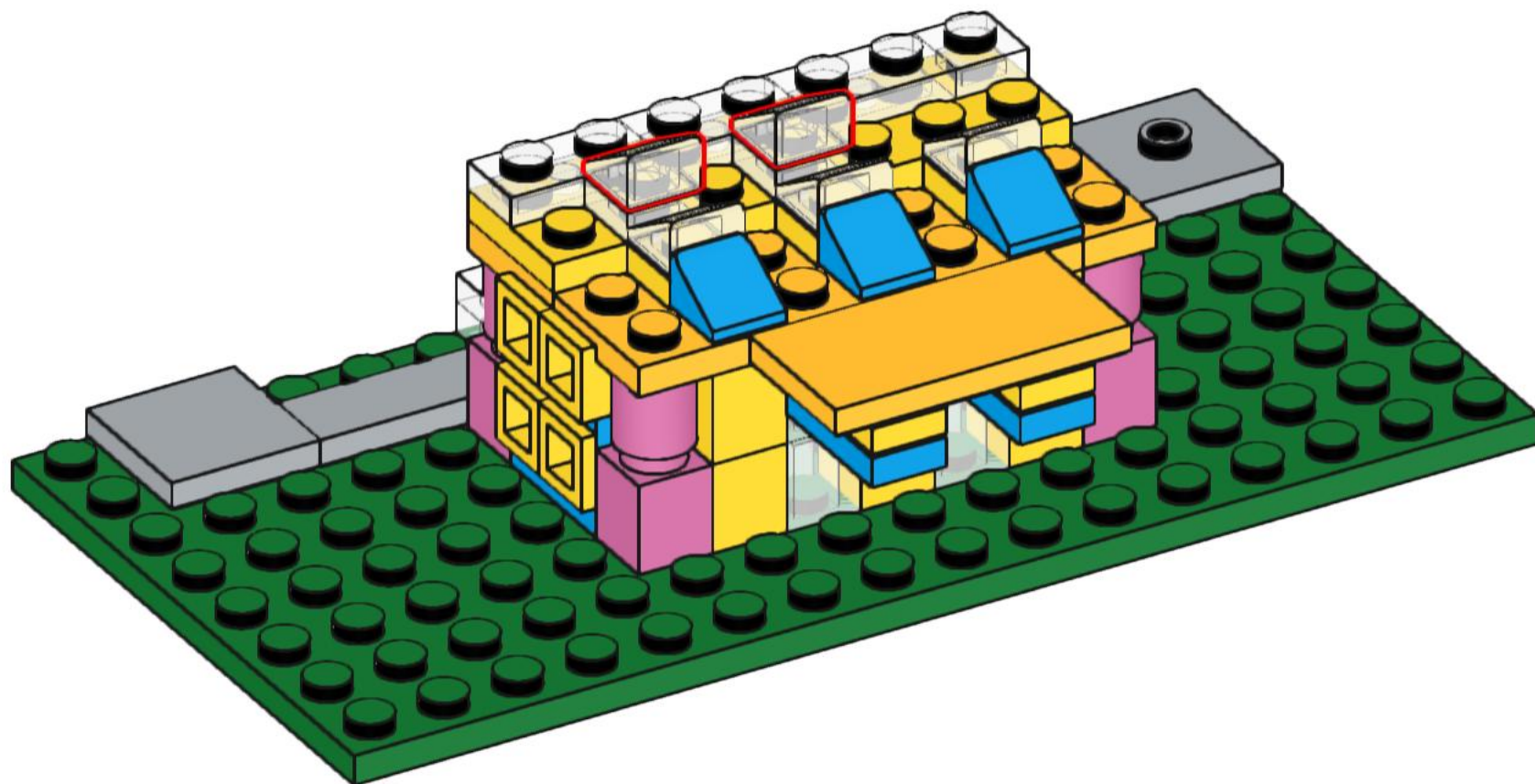

37

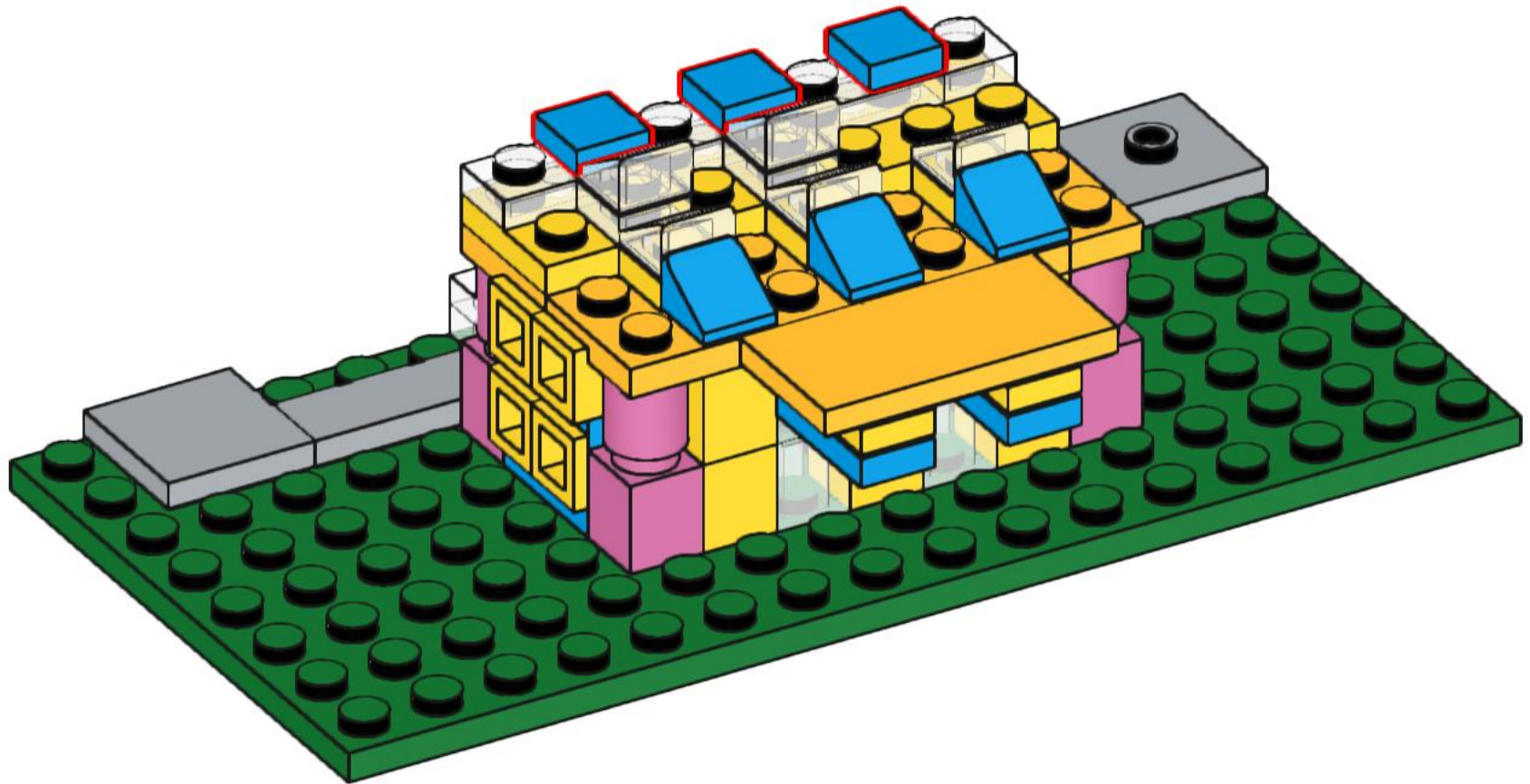

38

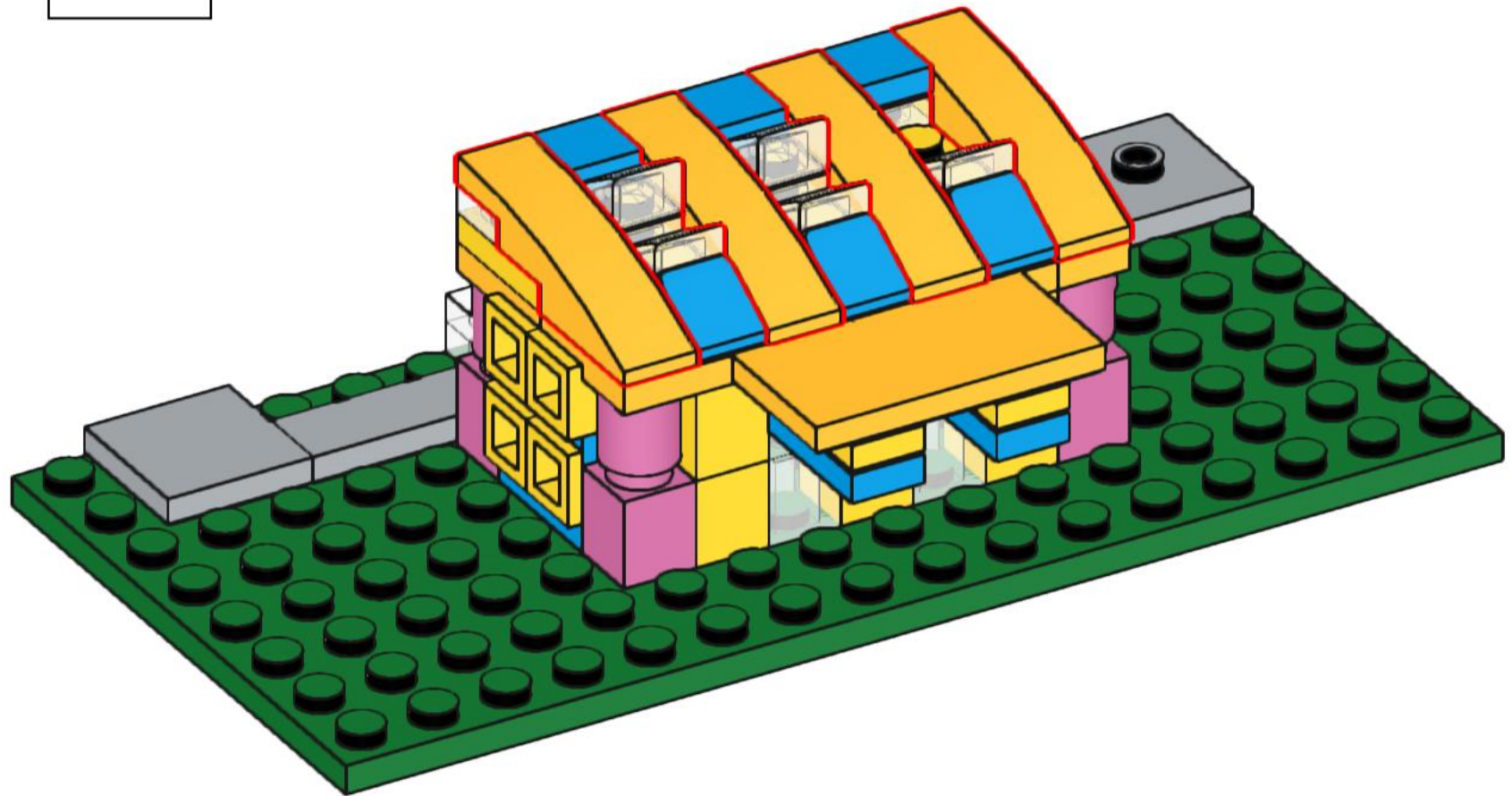
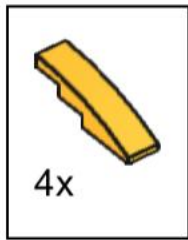

39

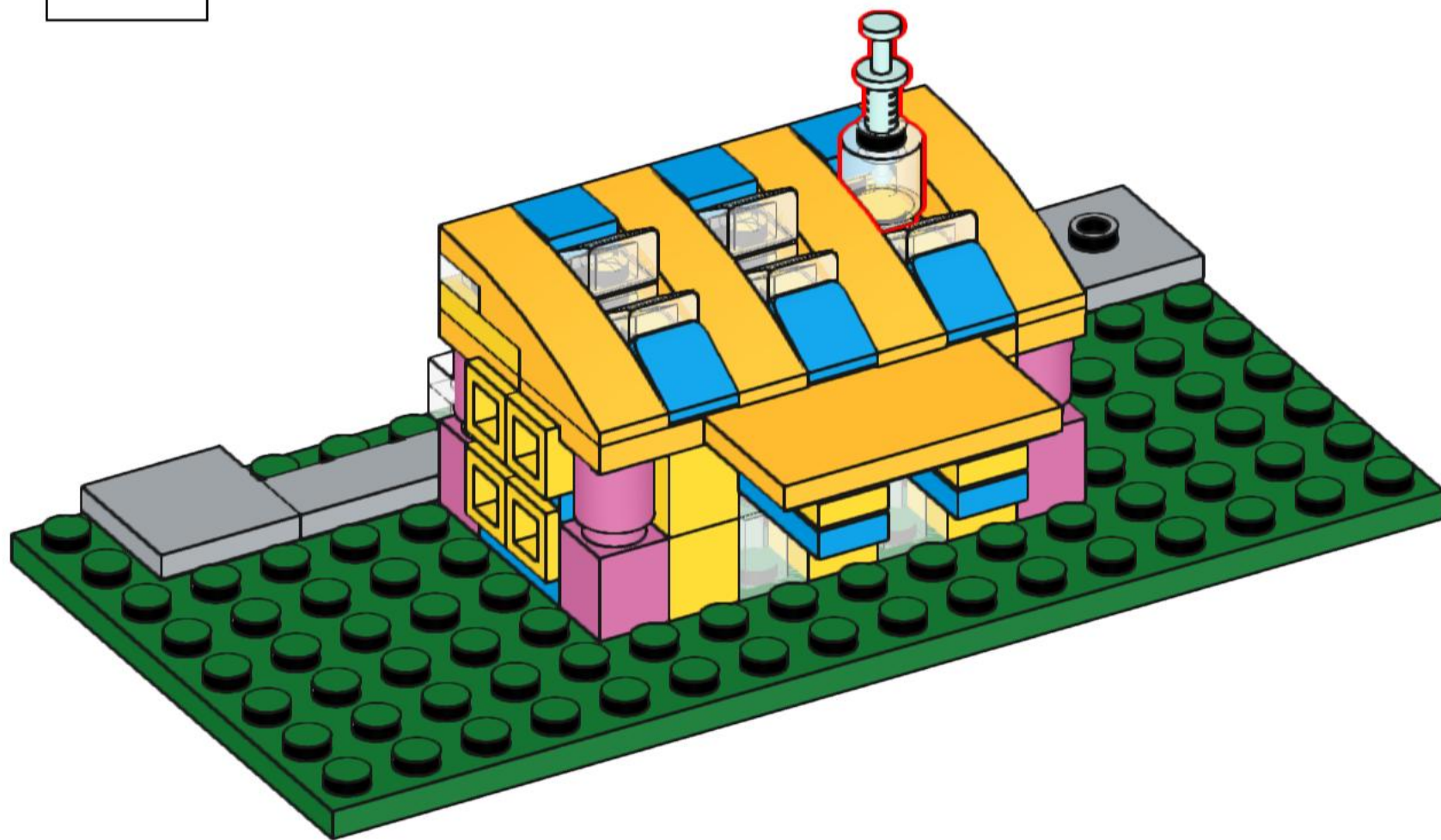
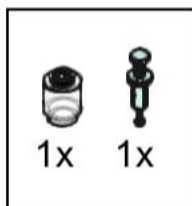

40

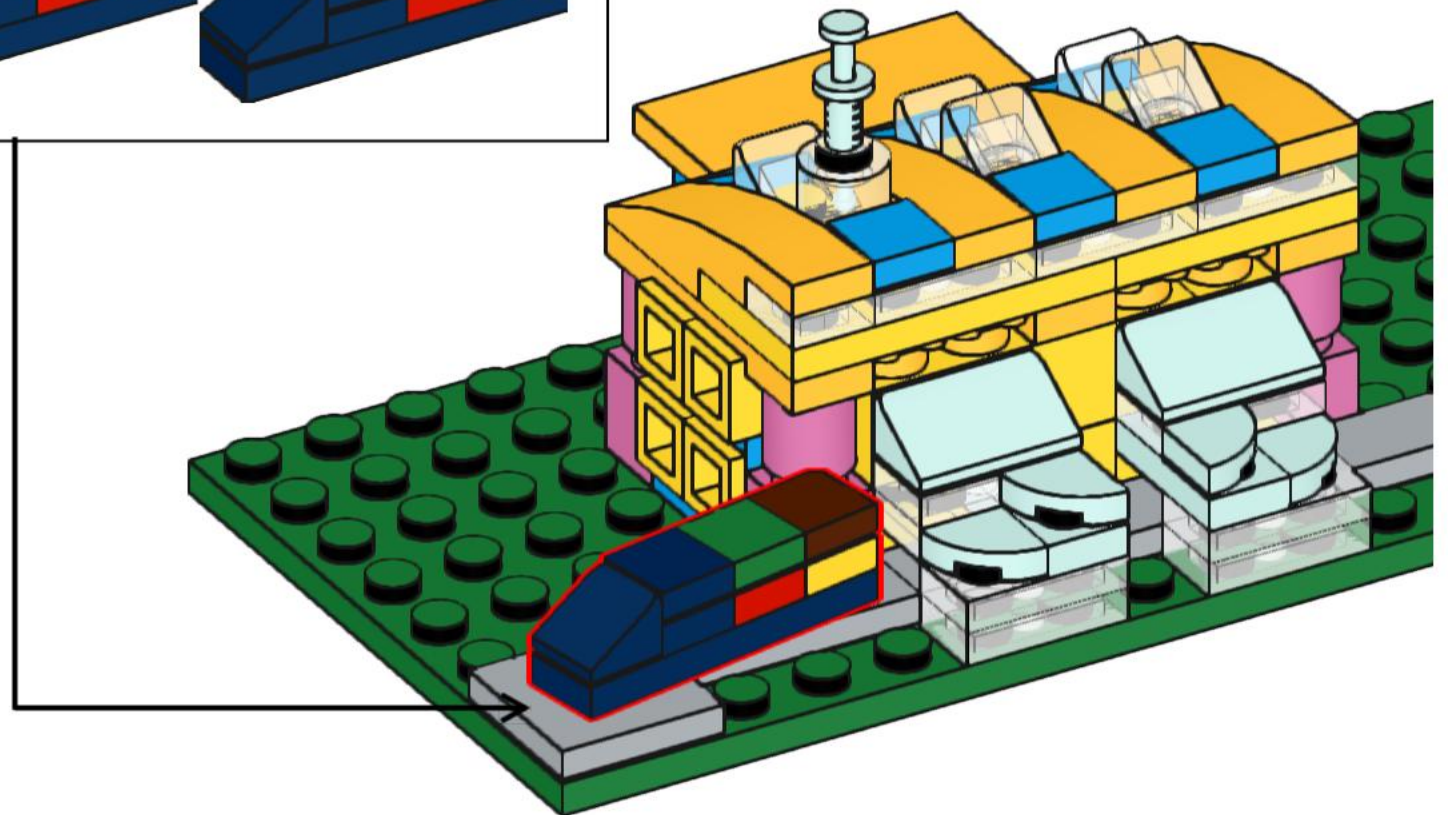
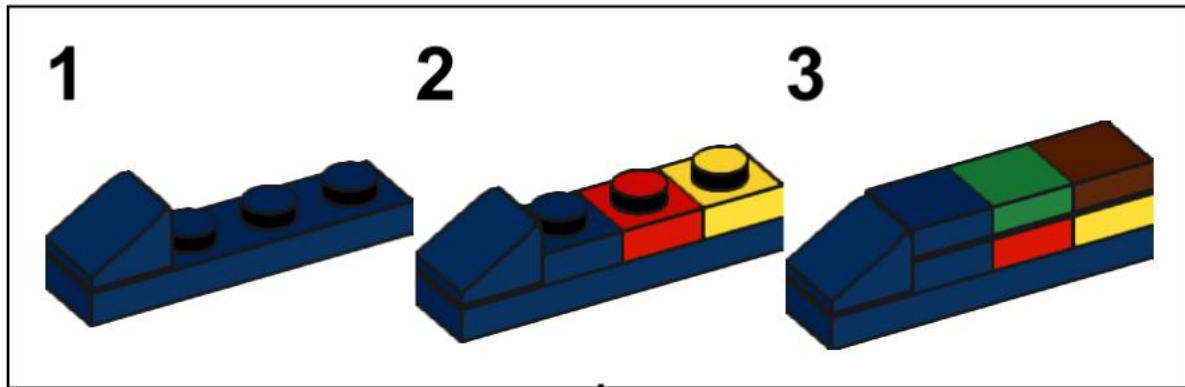
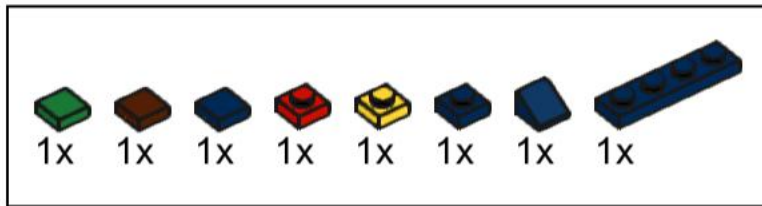

41

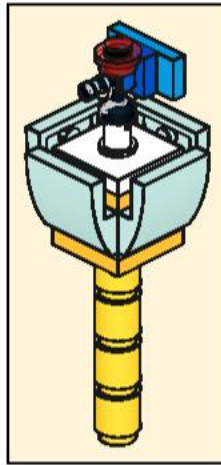
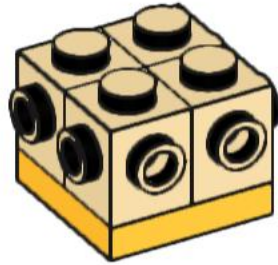
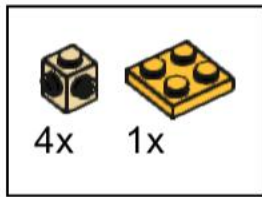

42

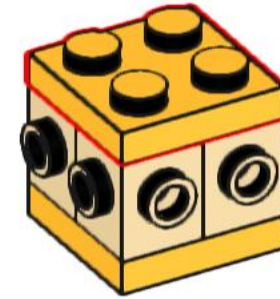
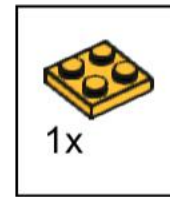

43

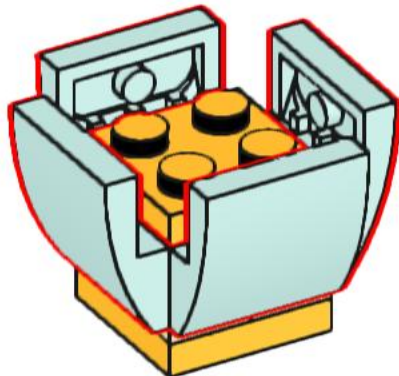

44

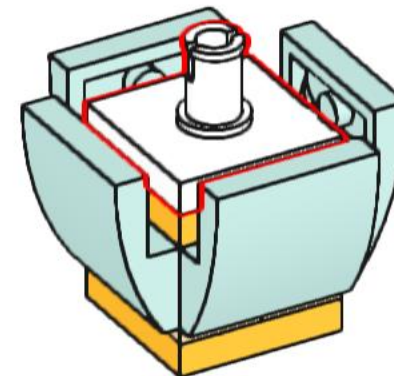
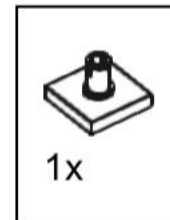

45

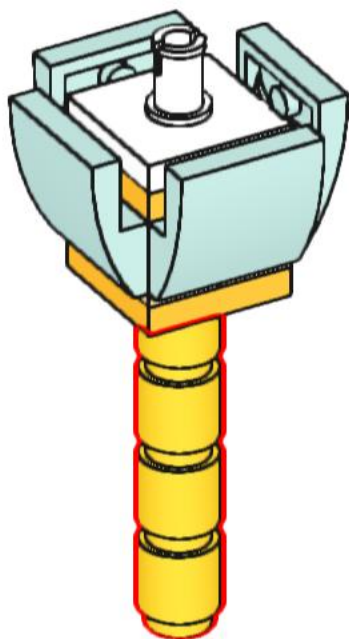
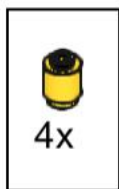

46

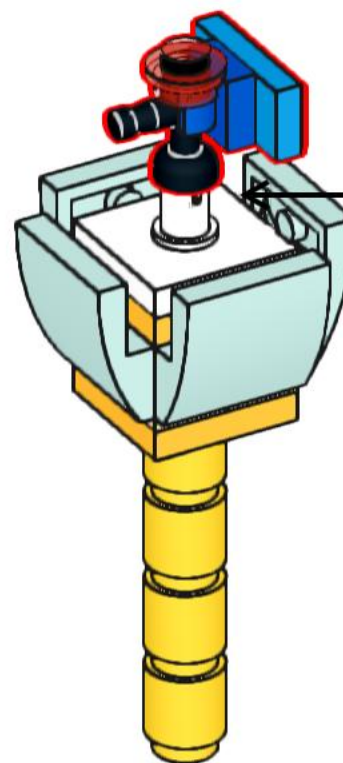
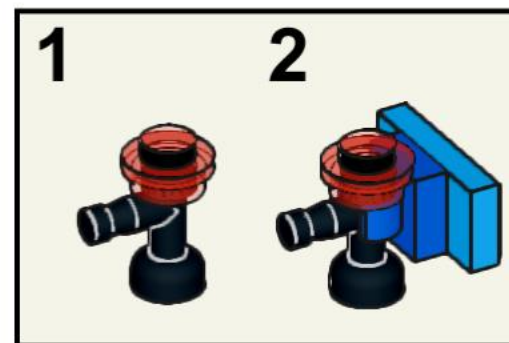
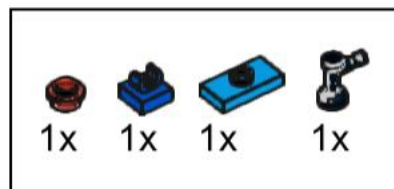

47

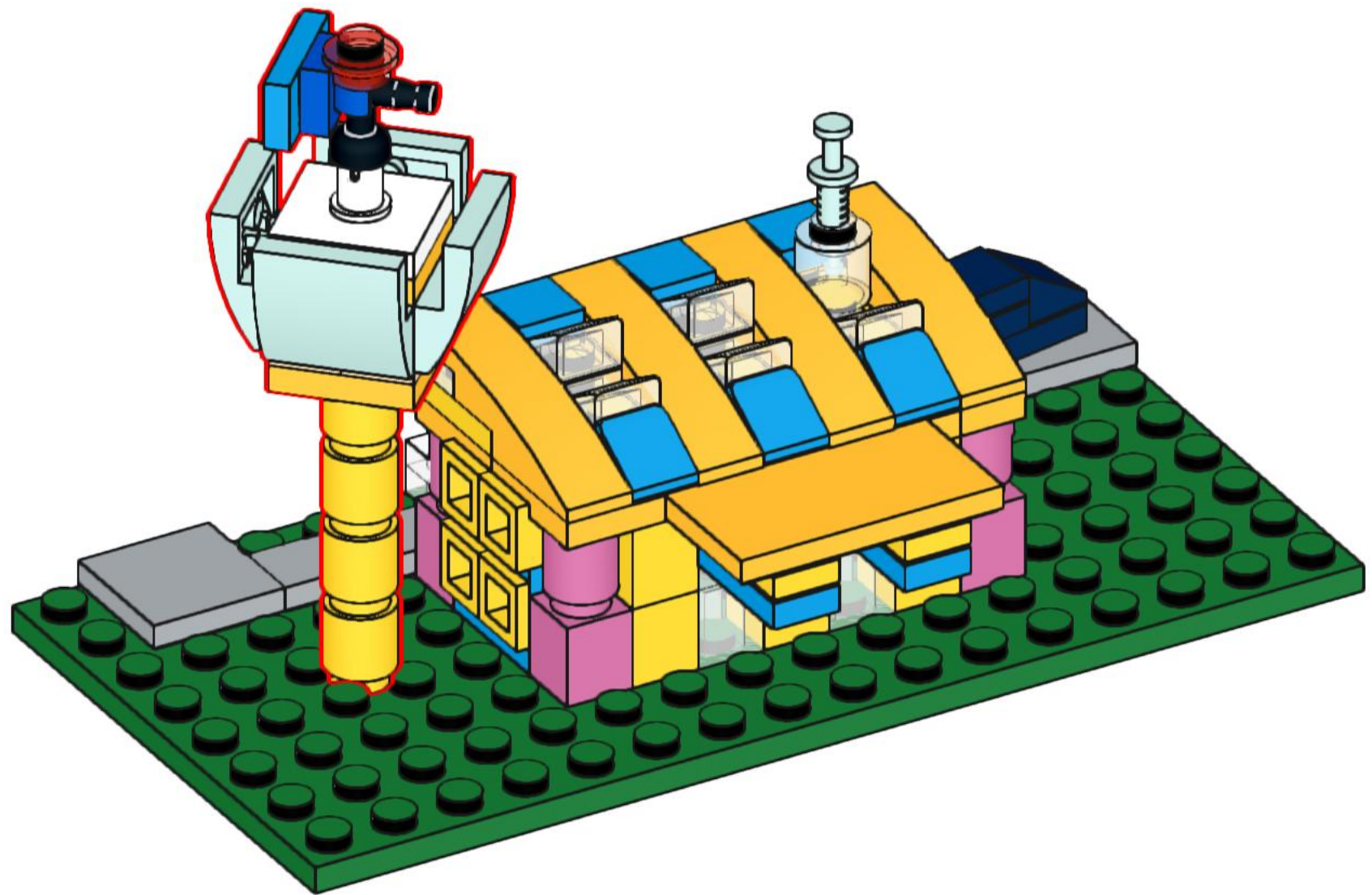

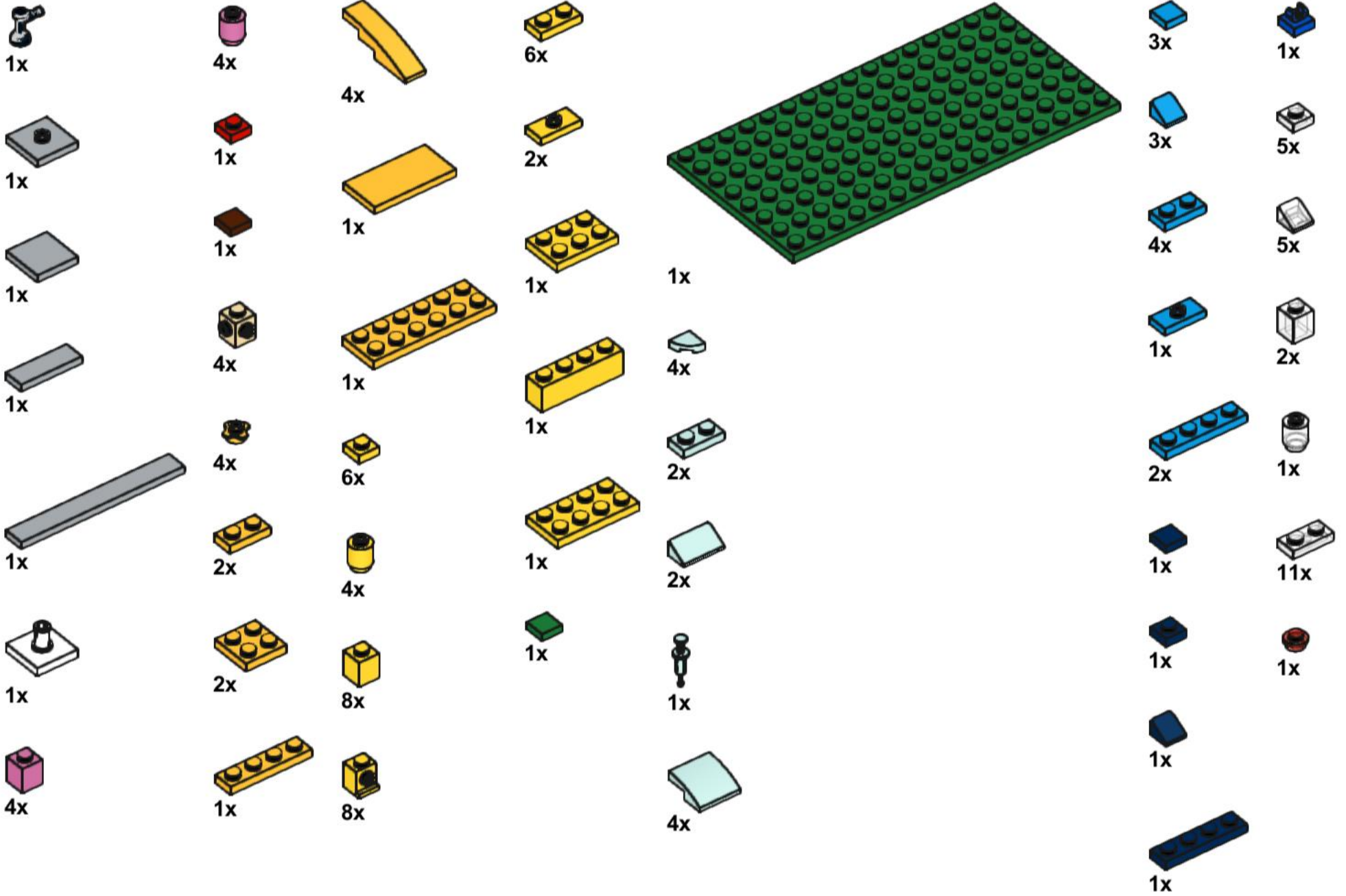



Save a Brick

giving used bricks a new chance

Share your experience

Did you enjoy building this MOC?
Let us know!

Share your build with us?
Send us a photo of the MOC in action.

✉ assemblytimes@save-a-brick.com

Stay in touch

www.save-a-brick.com

[instagram.com/sleepswithlego](https://www.instagram.com/sleepswithlego)

[facebook.com/SaveAnotherBrick](https://www.facebook.com/SaveAnotherBrick)

[pinterest.com/saveabrick](https://www.pinterest.com/saveabrick)