

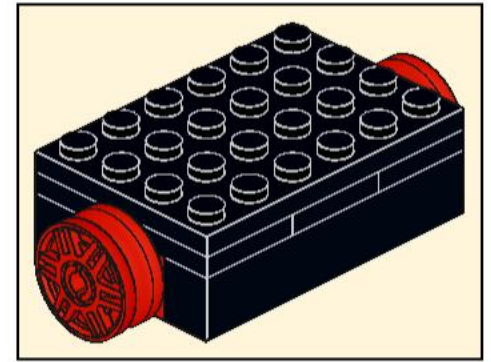

**2021004**  
**Vintage**  
**Tram**

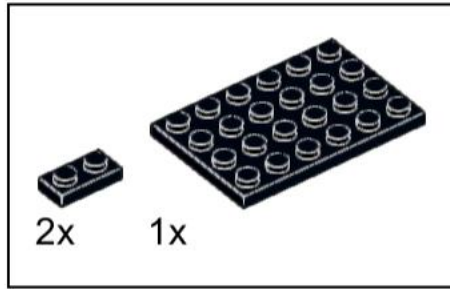

1



2x

2

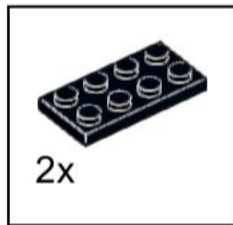

3

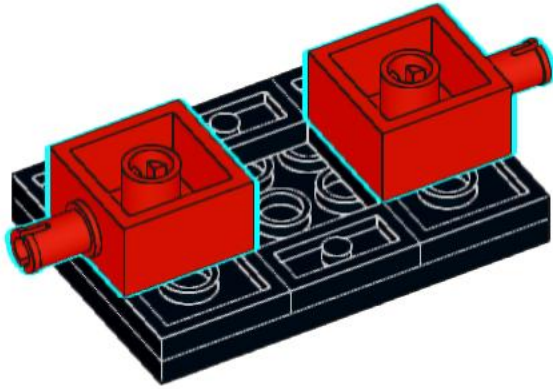
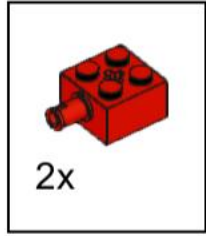

4

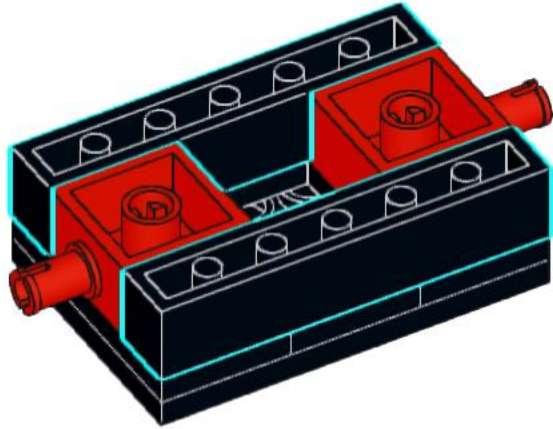
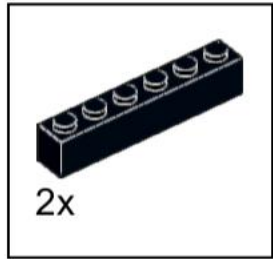

5

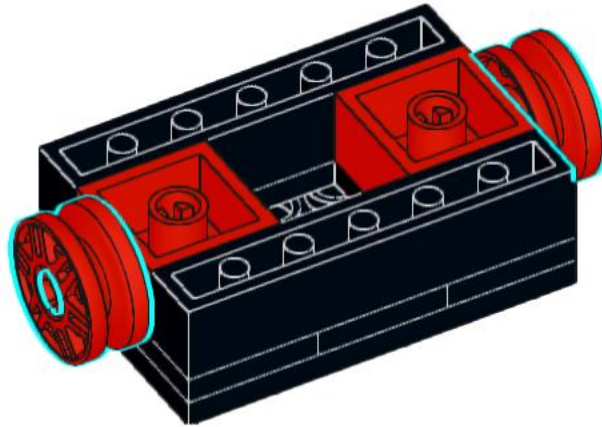
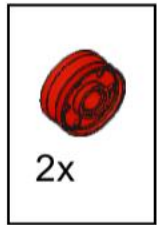

6

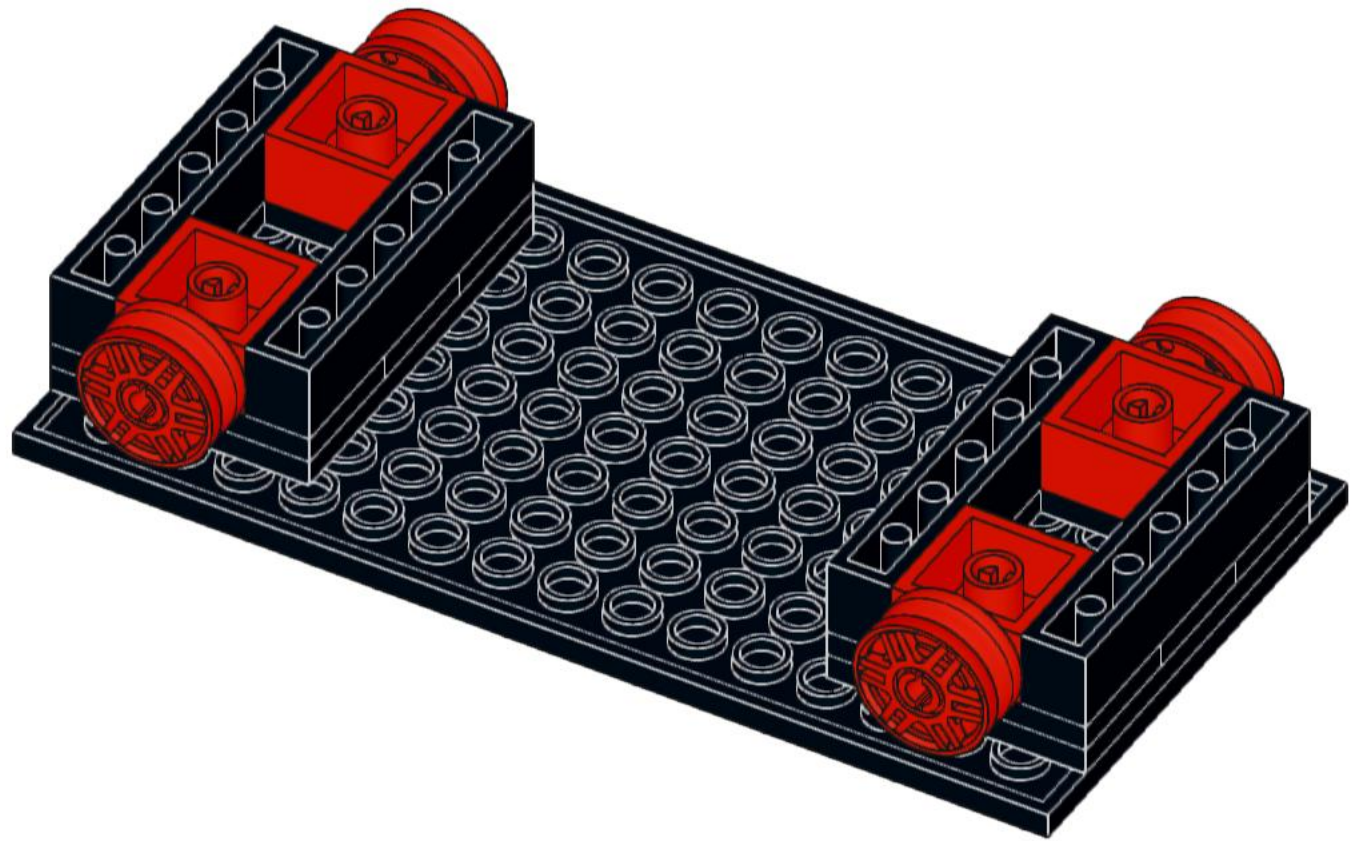
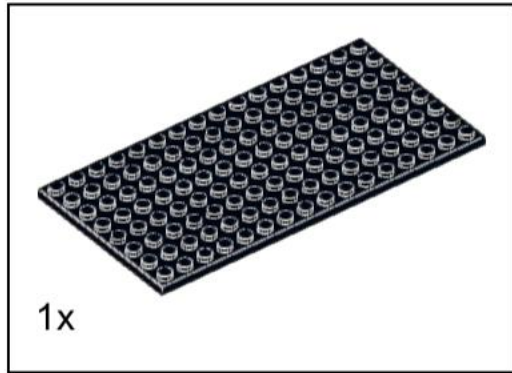

7

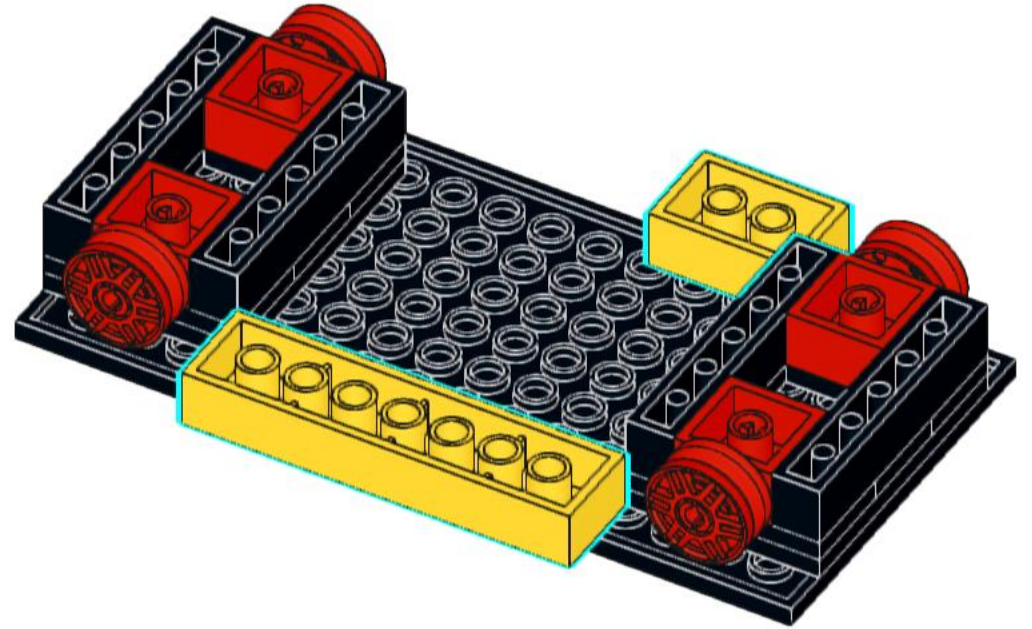
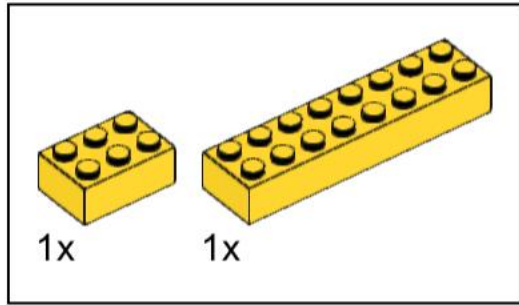

8

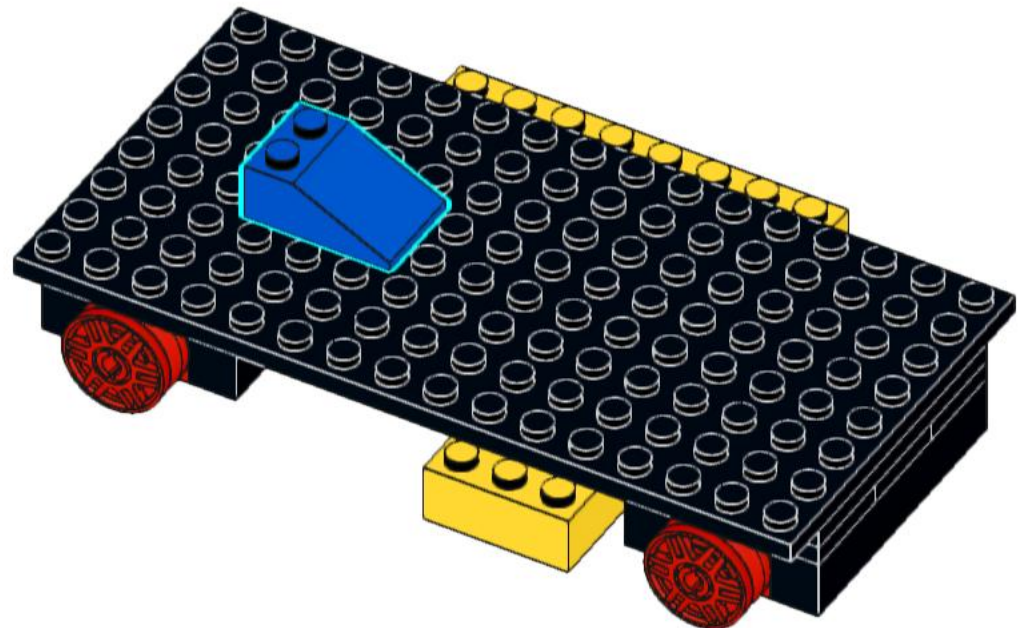
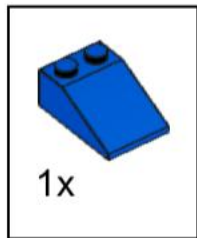

9

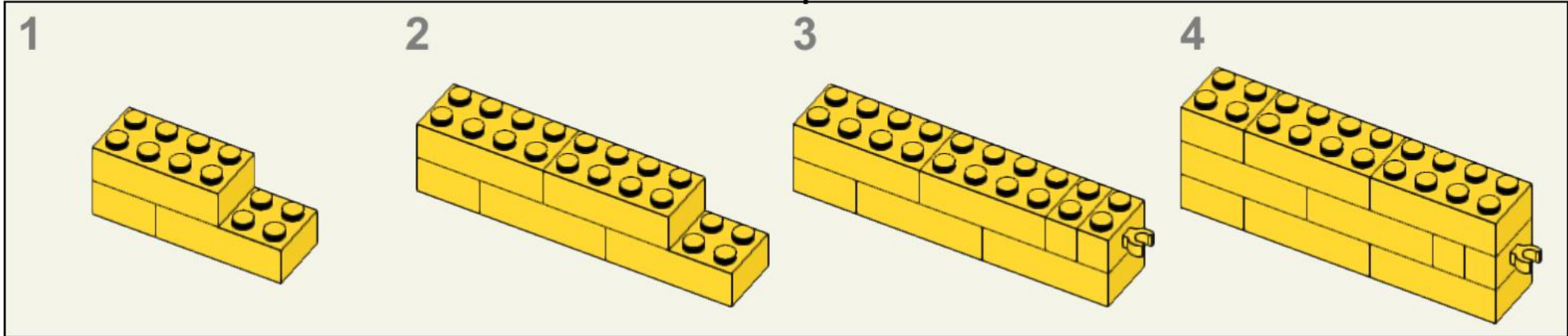
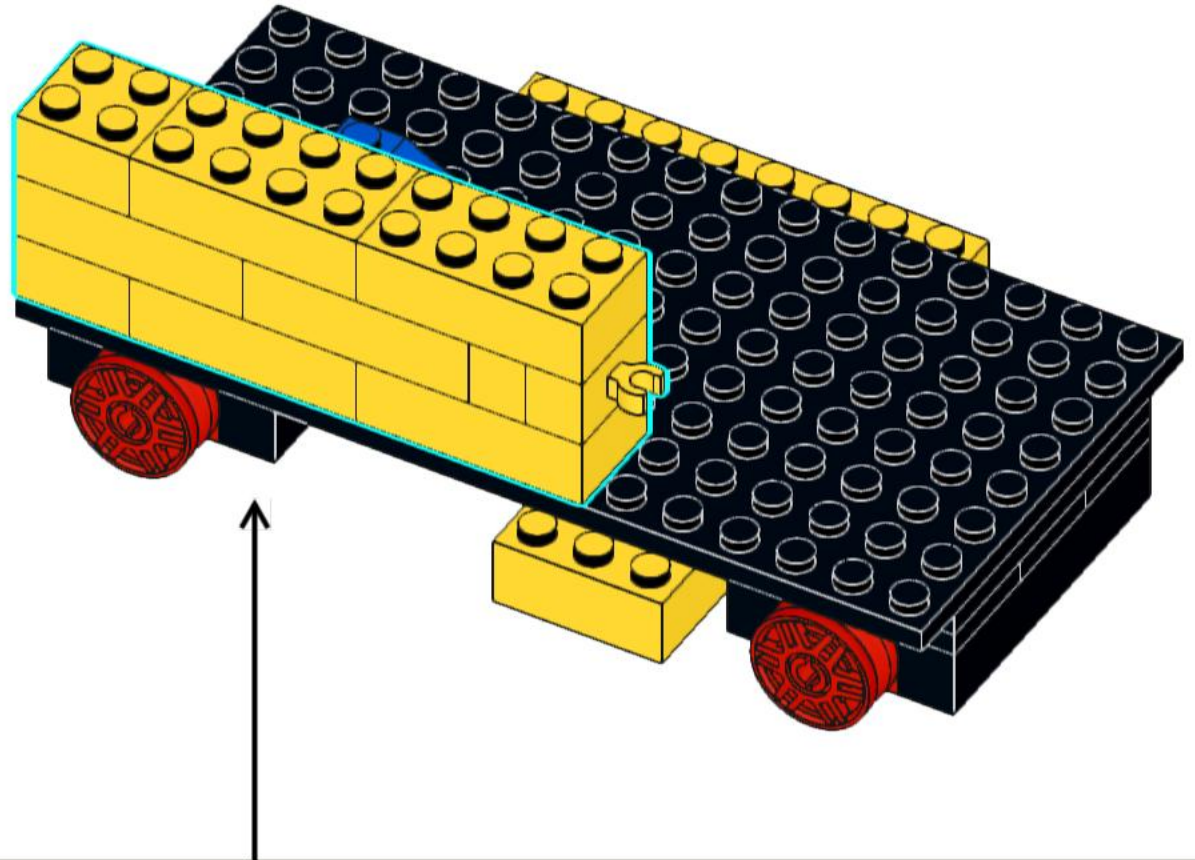
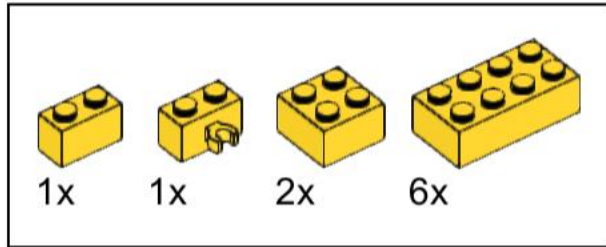

# 10

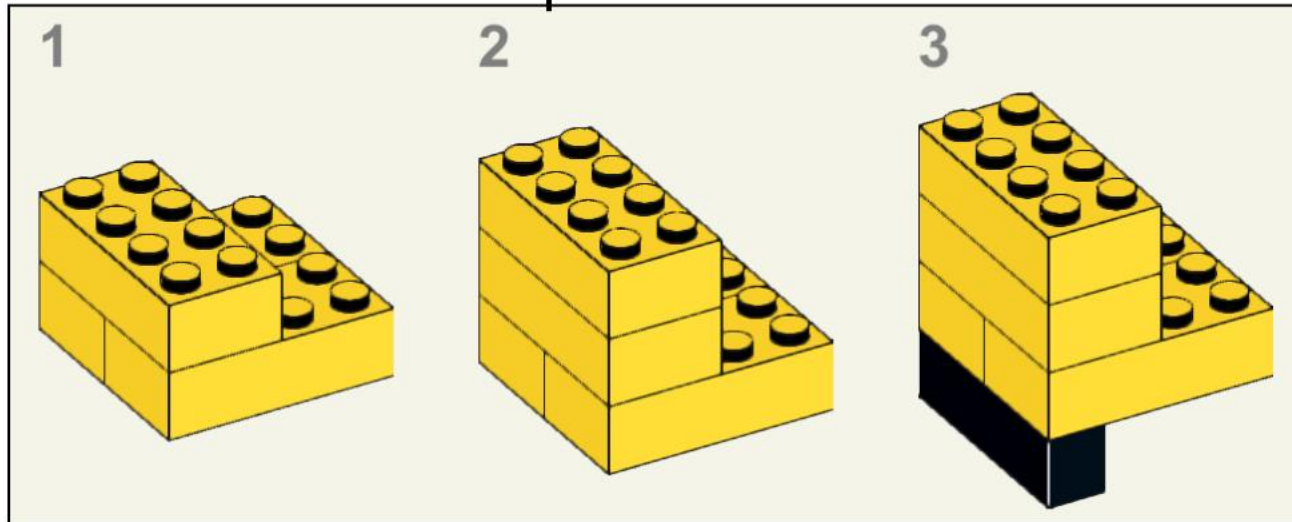
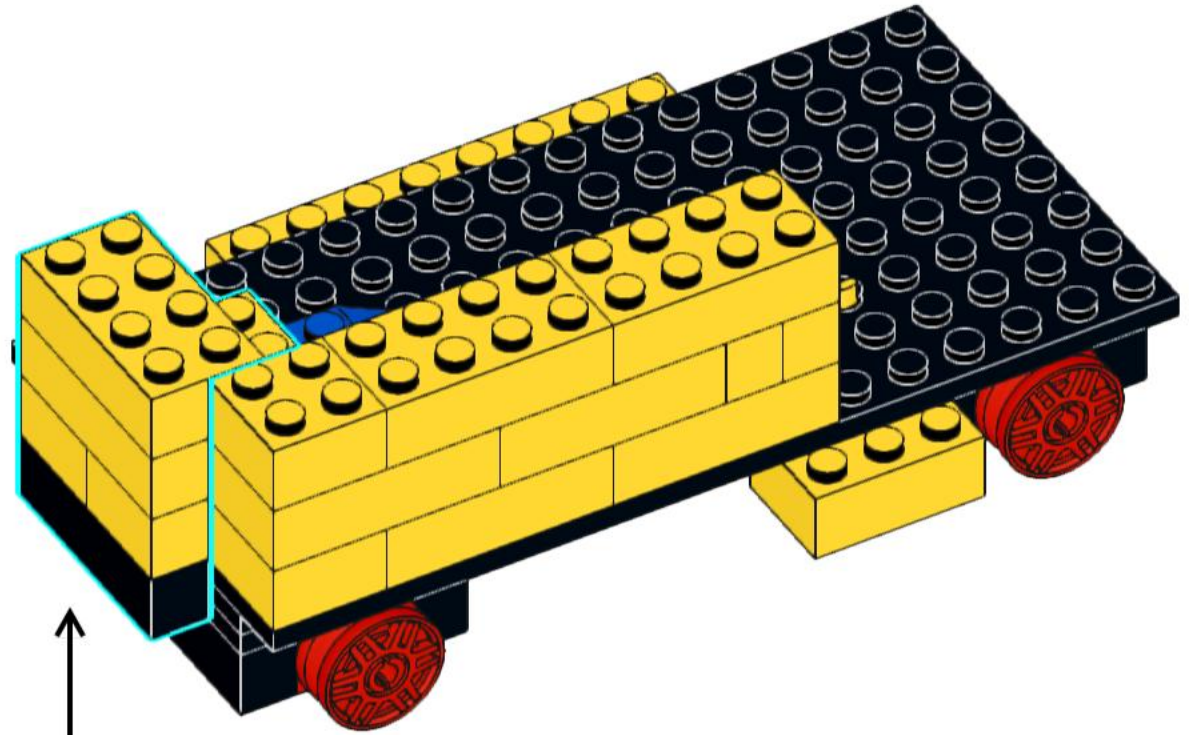
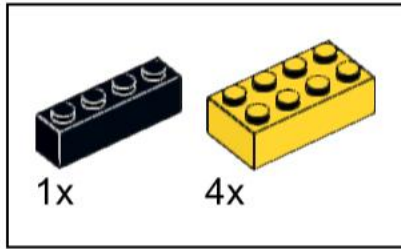

11

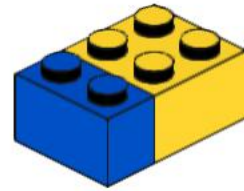
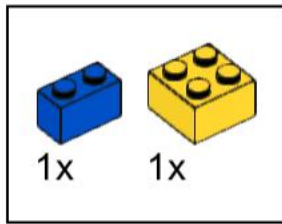

12

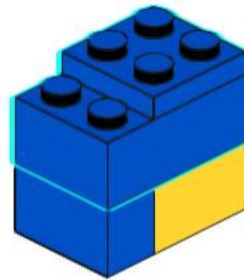
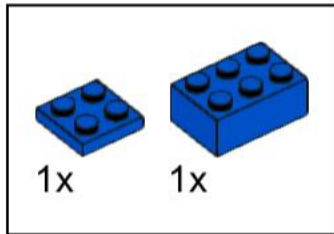

13

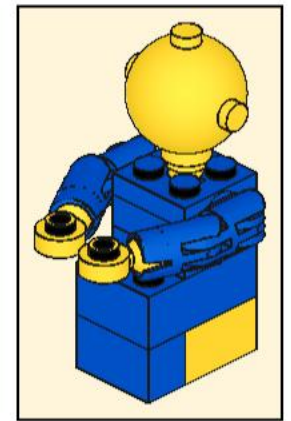
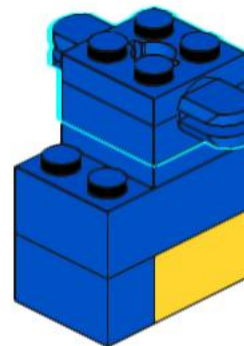
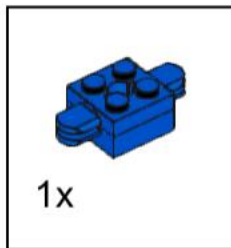



# 14

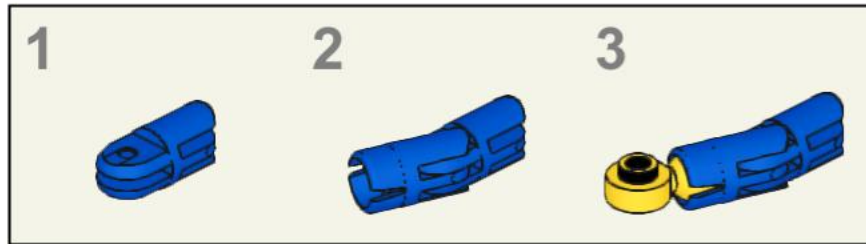
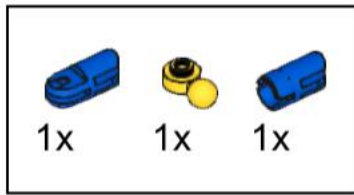

# 15

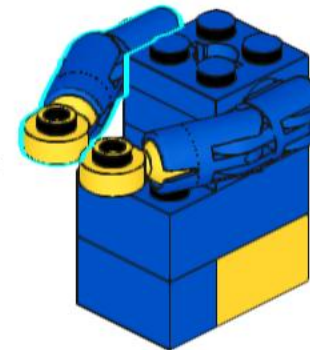
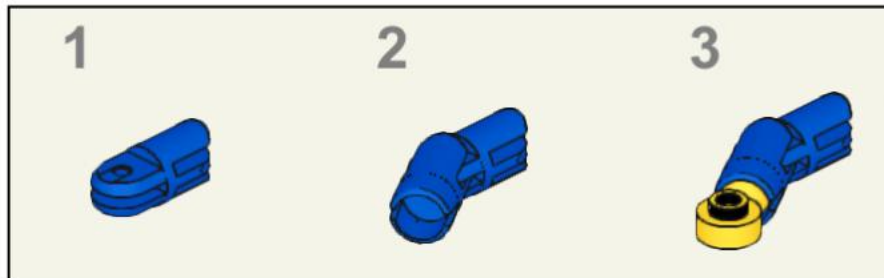
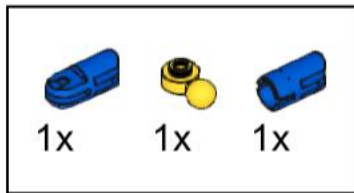

16

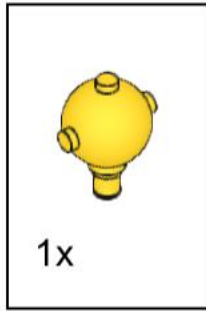

17

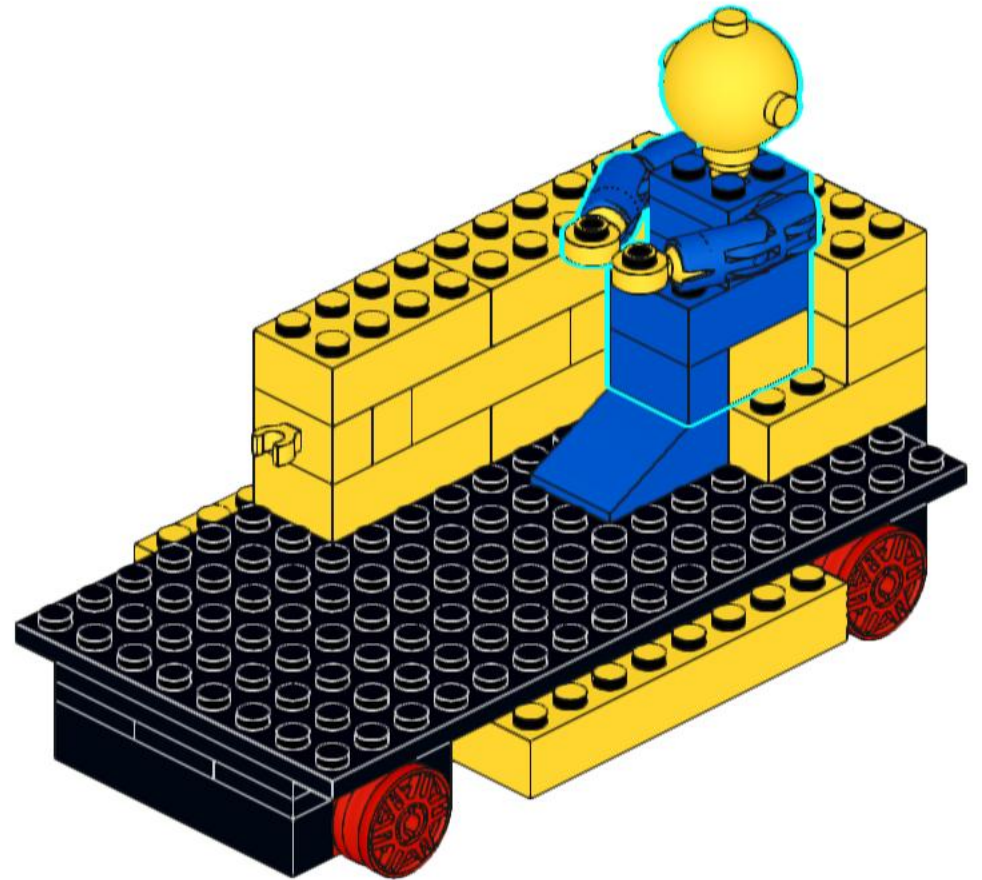
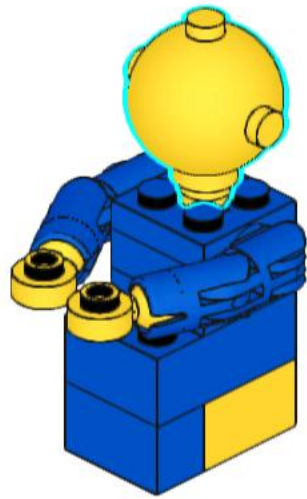

# 18

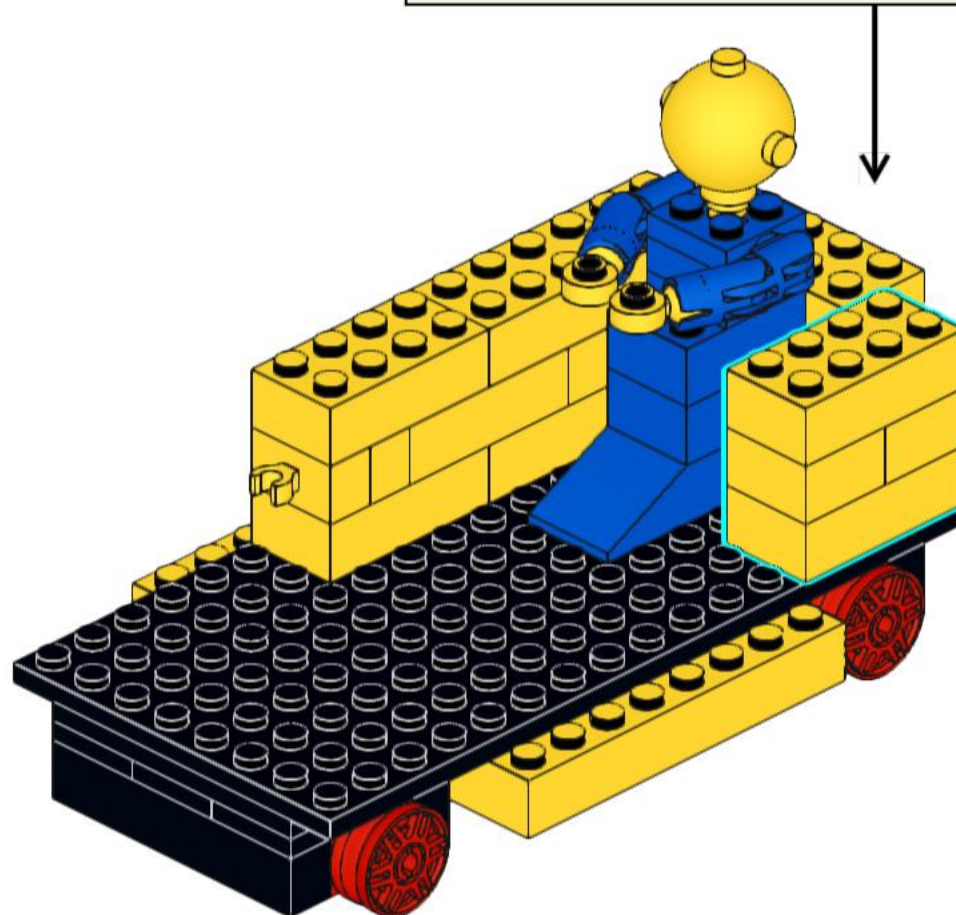
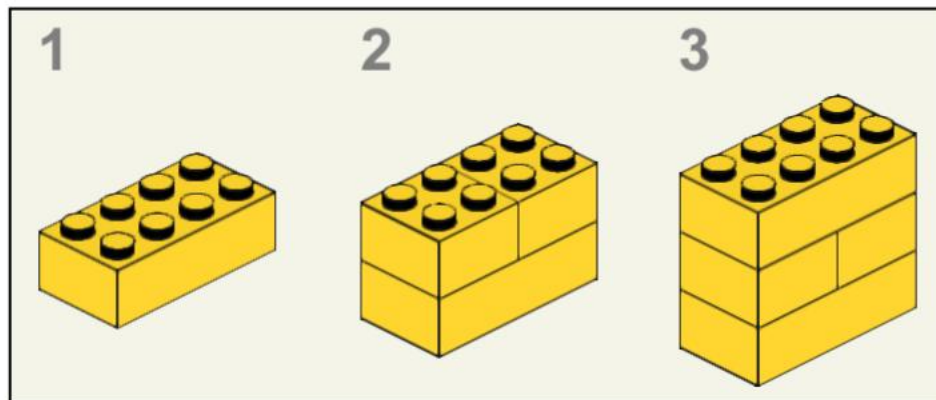
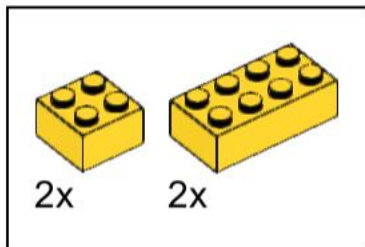

# 19

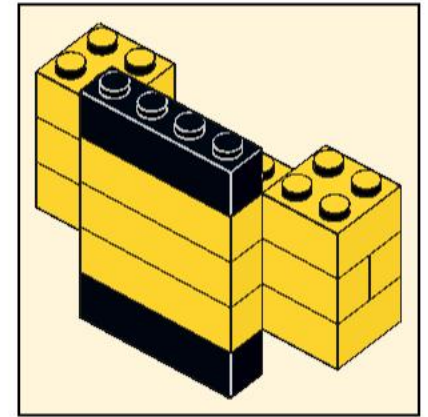
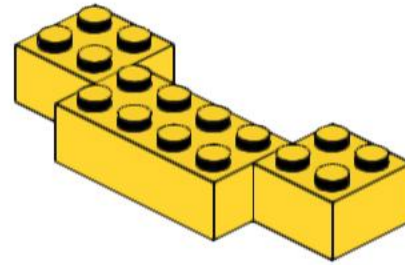
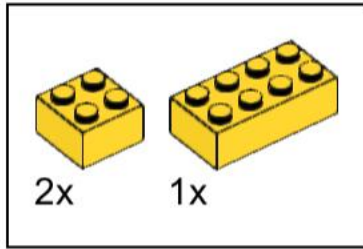

# 20

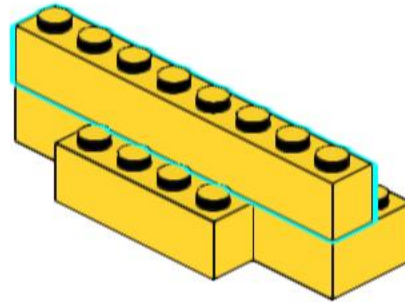
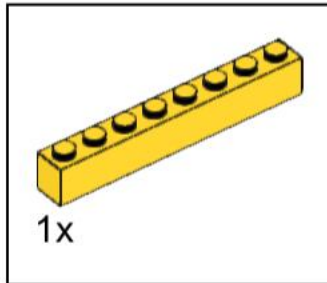

# 21

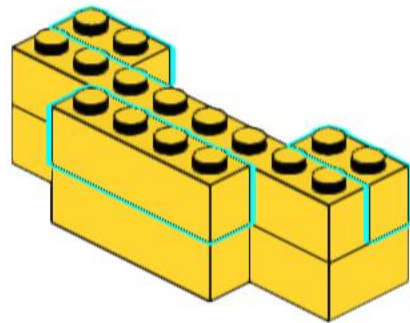
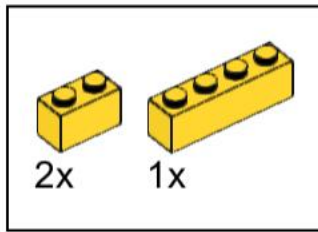

# 22

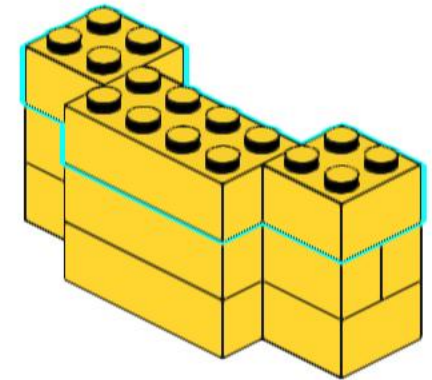
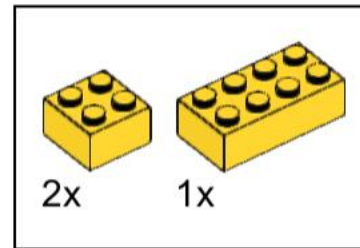

# 23

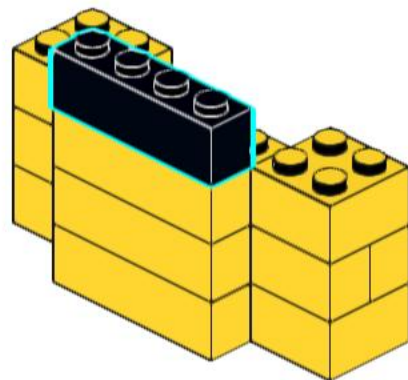
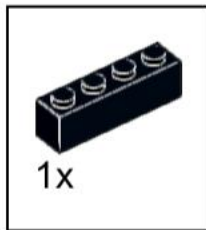

# 24

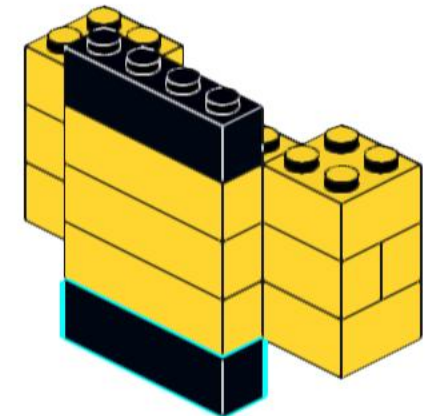
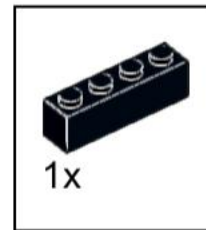

# 25

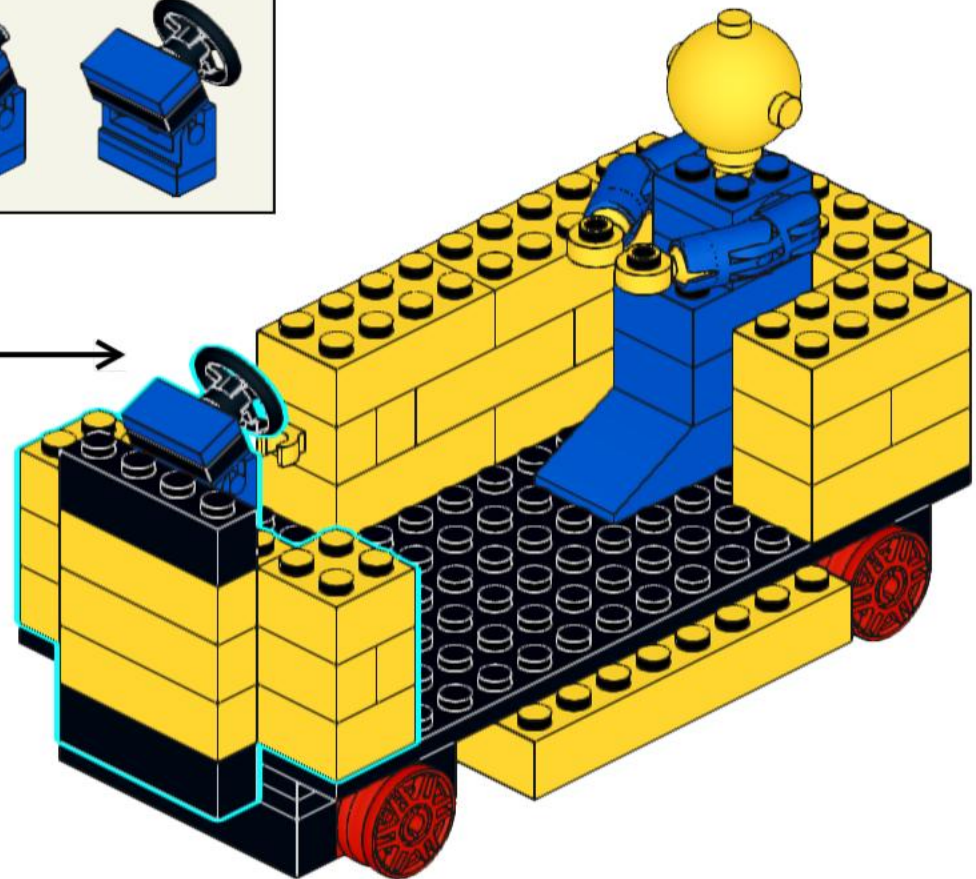
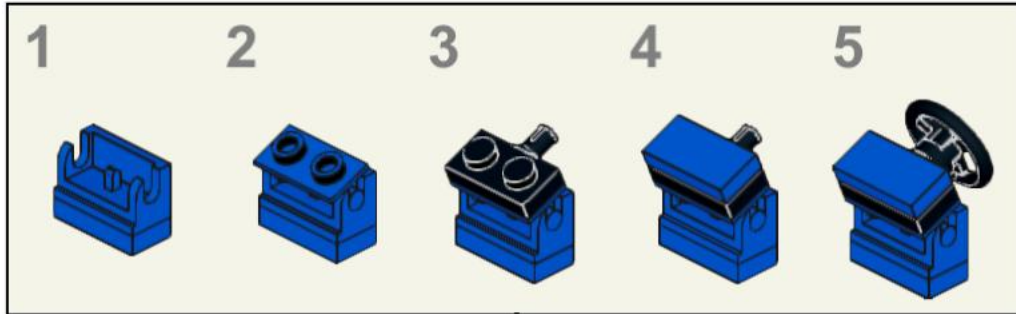
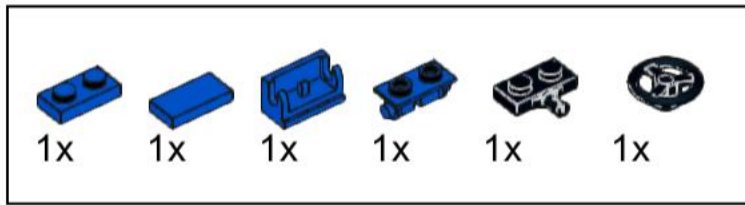

# 26

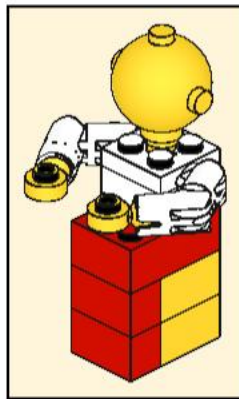
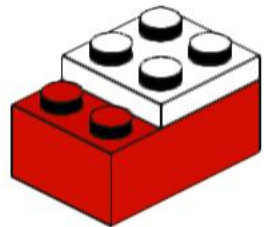
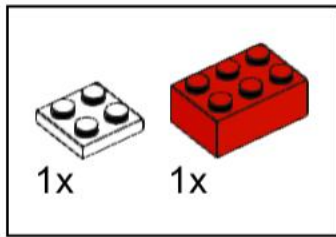

# 27

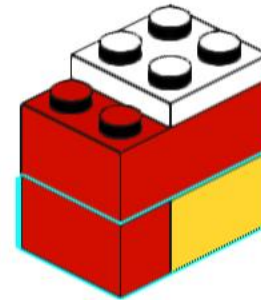
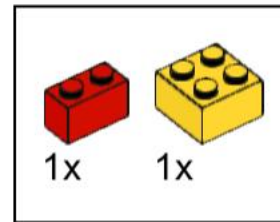

# 28

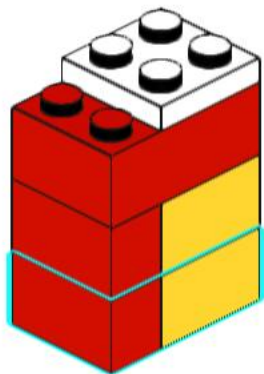
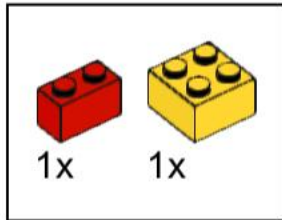

# 29

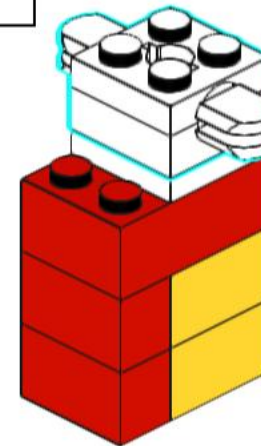
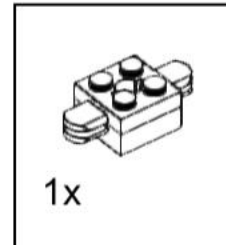

# 30

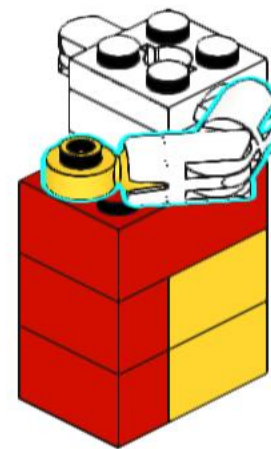
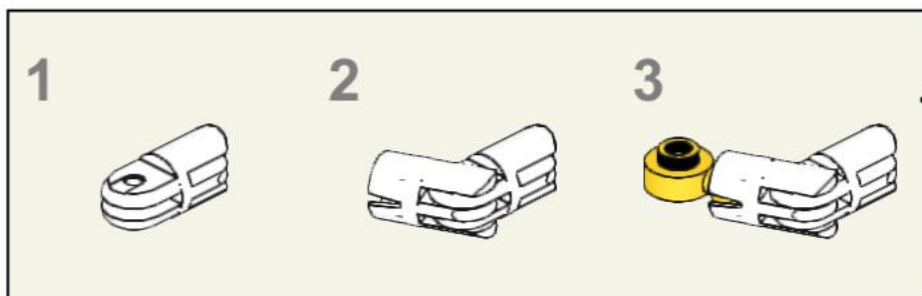
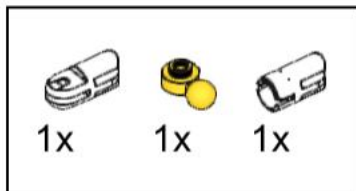

# 31

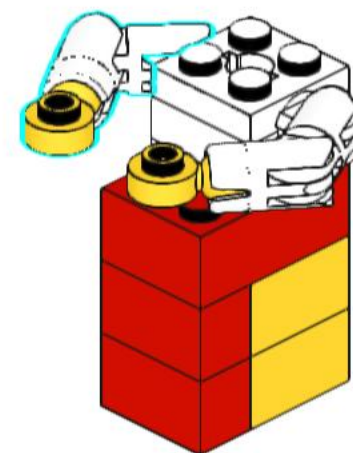
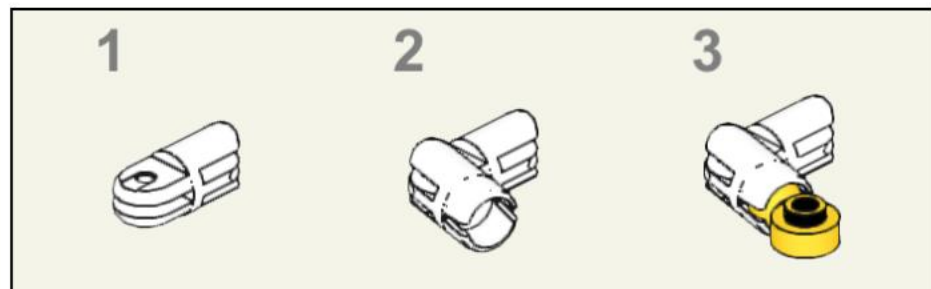
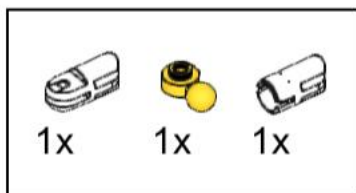



32

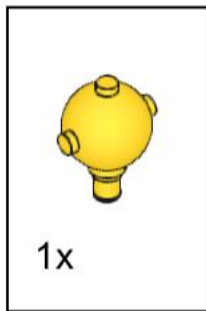

33

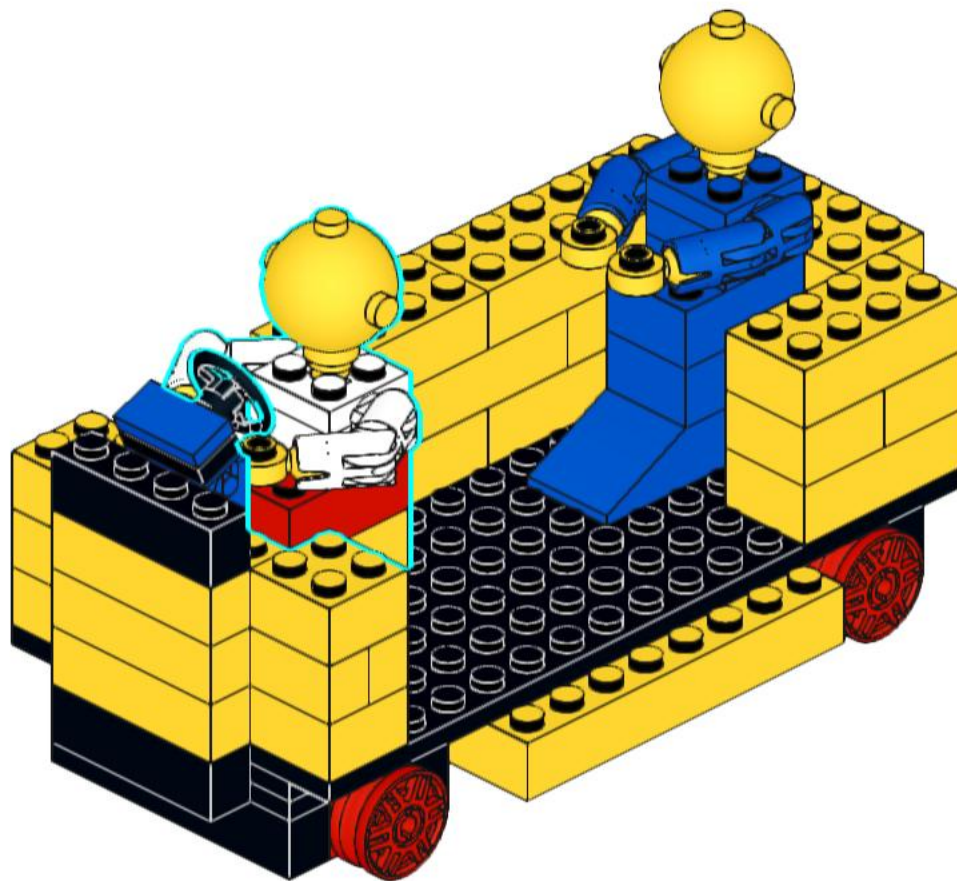
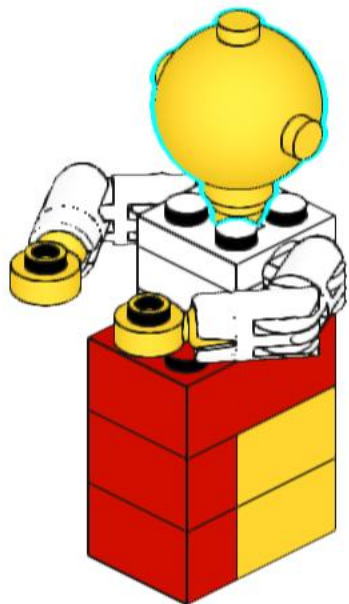

34

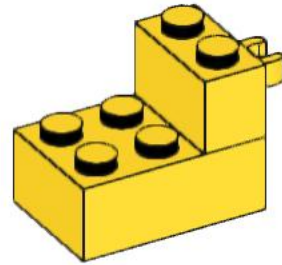
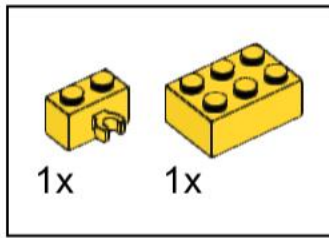

35

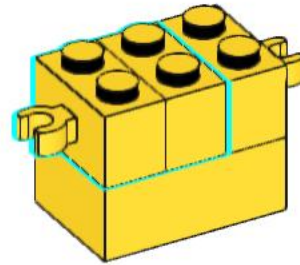
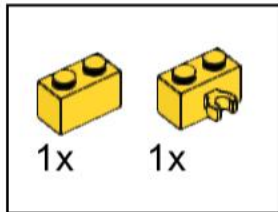

36

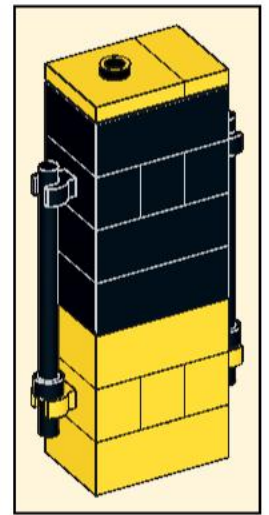
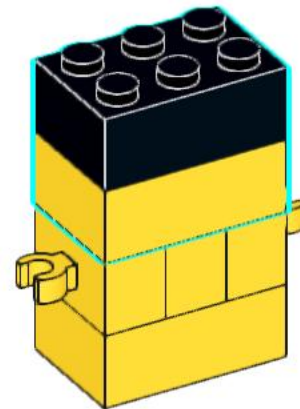
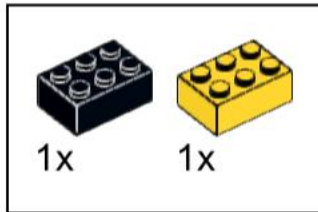

# 37

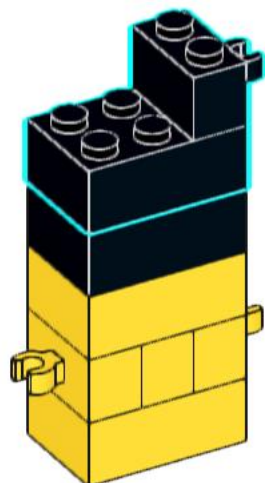
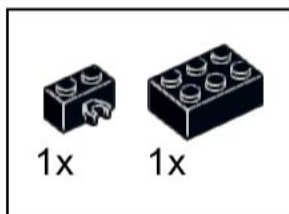

# 38

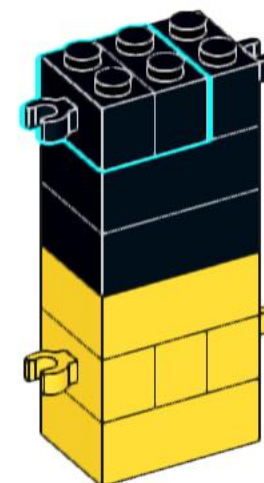
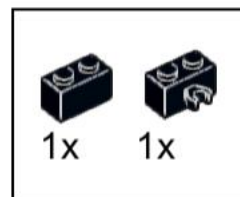

# 39

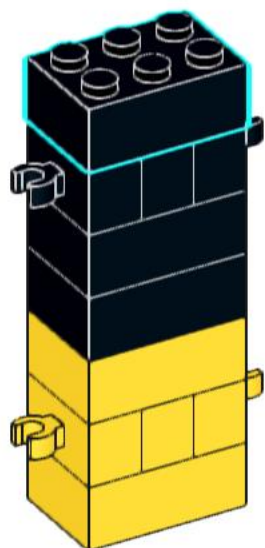
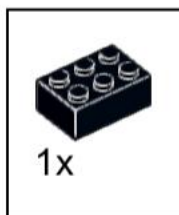

# 40

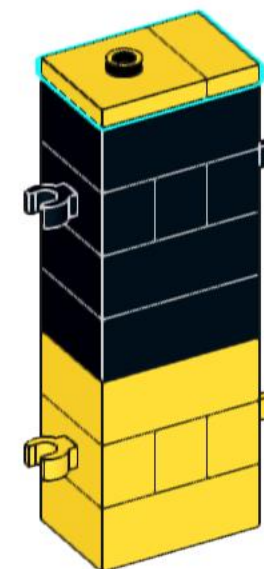
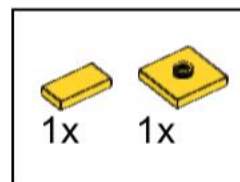

41

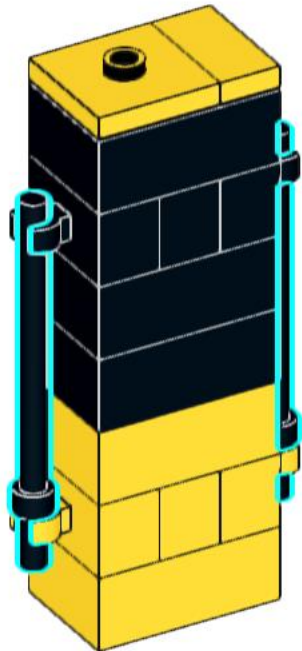

42

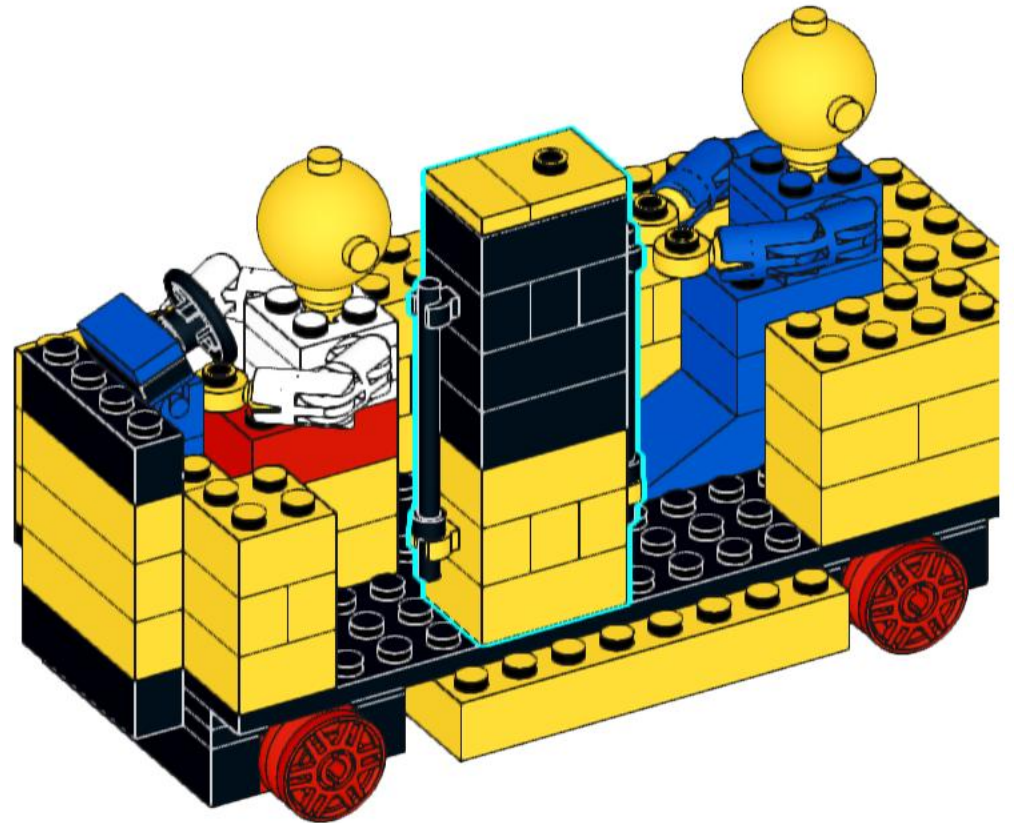

# 43

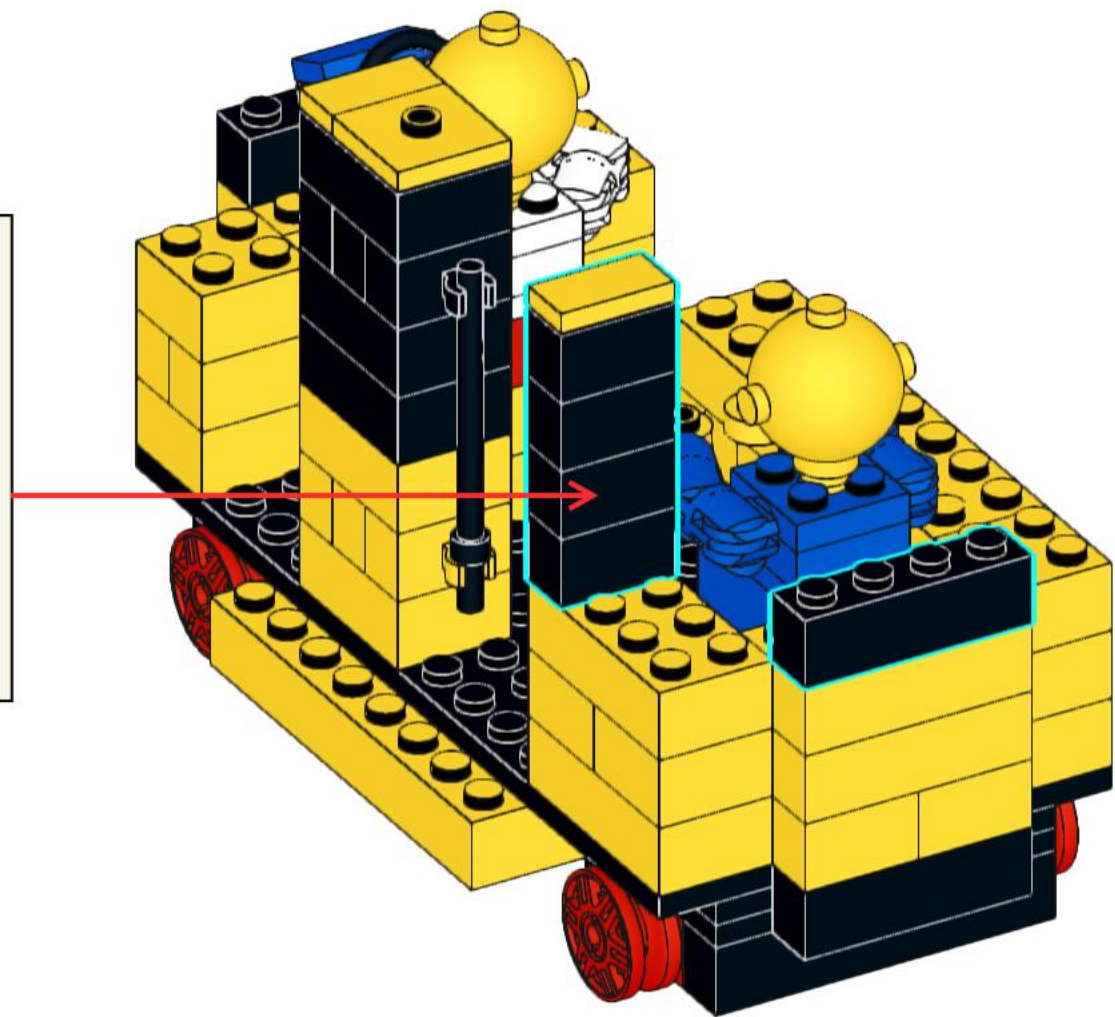
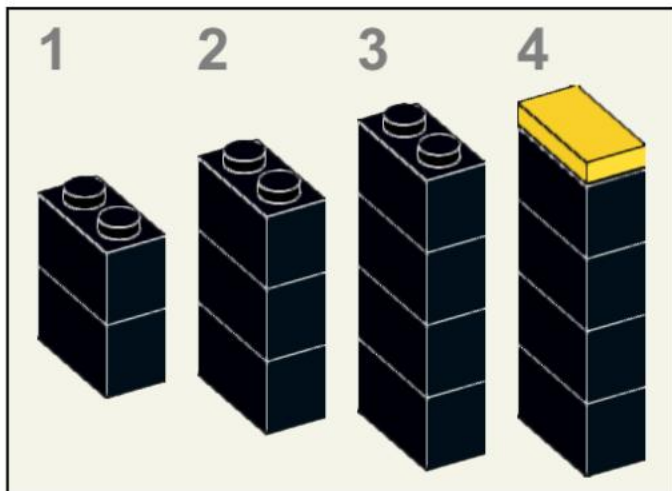
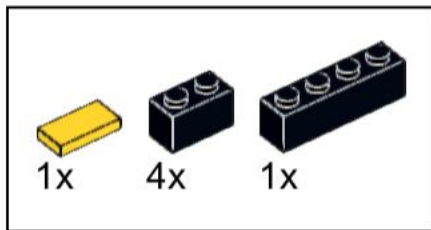

44

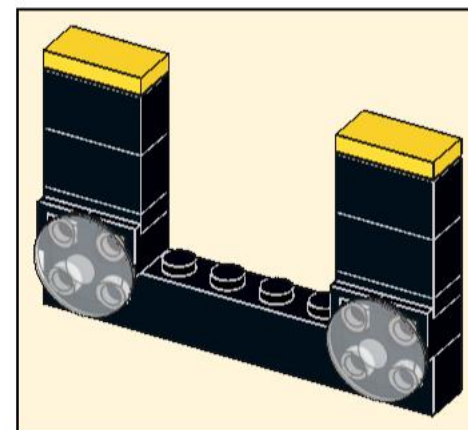
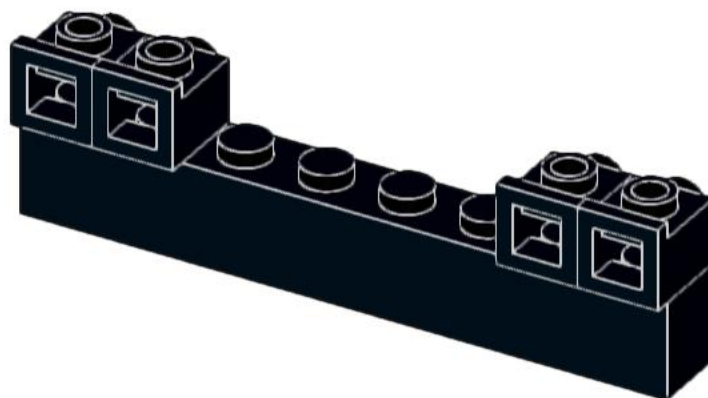
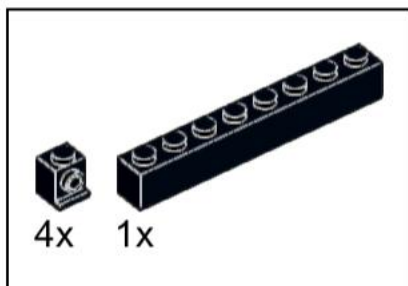

45

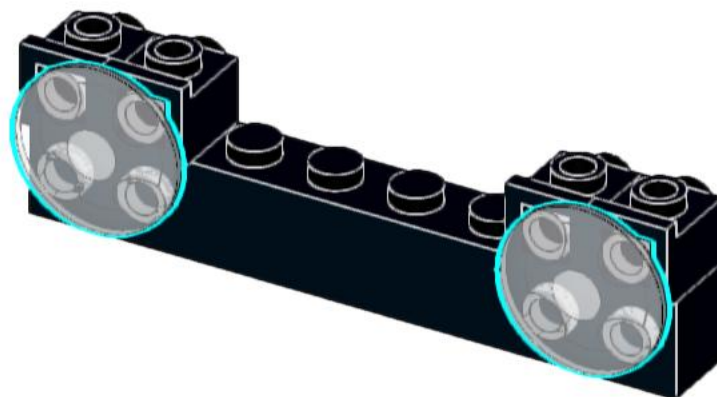
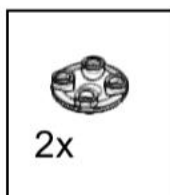

46

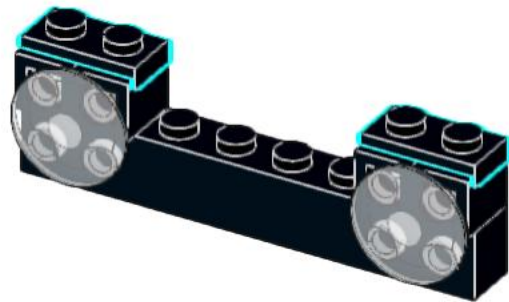

47

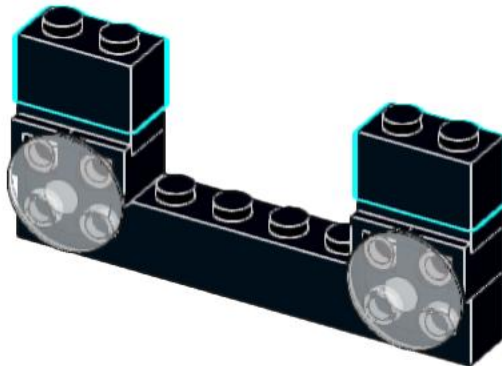
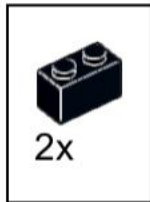

48

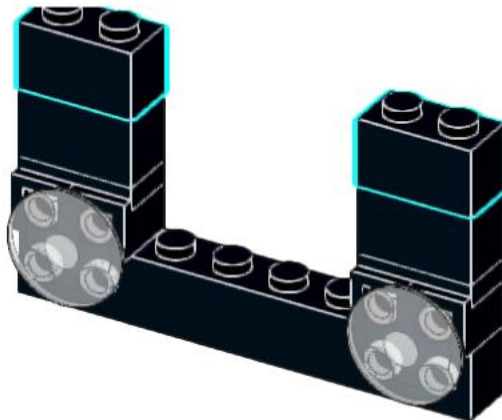
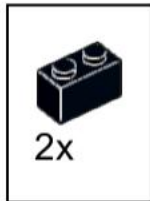

49

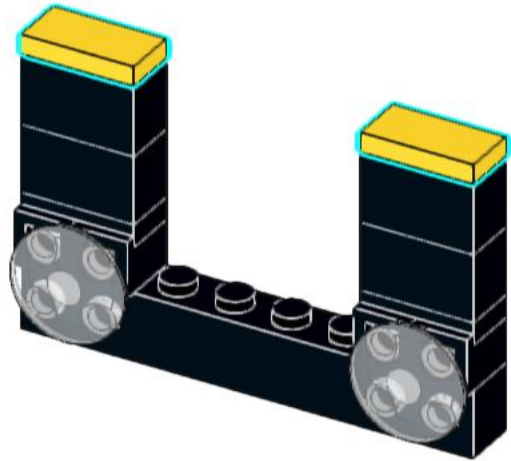
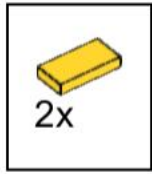

50

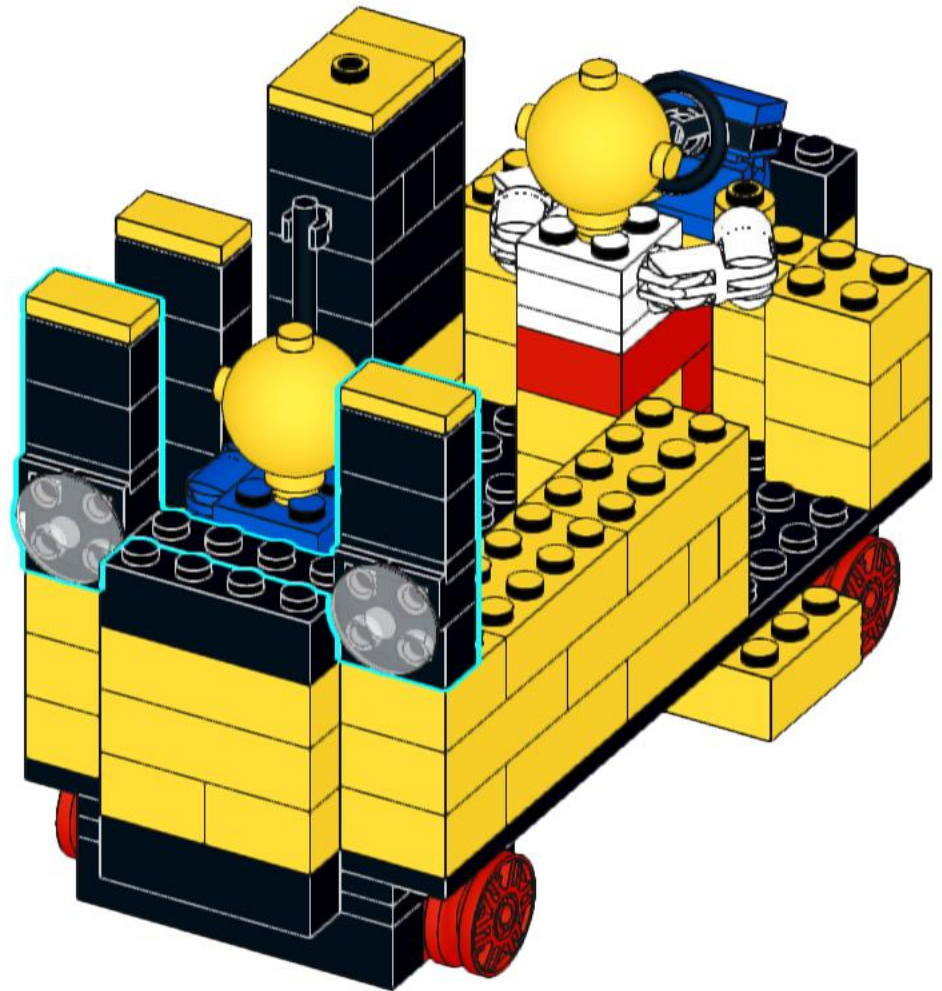



# 51

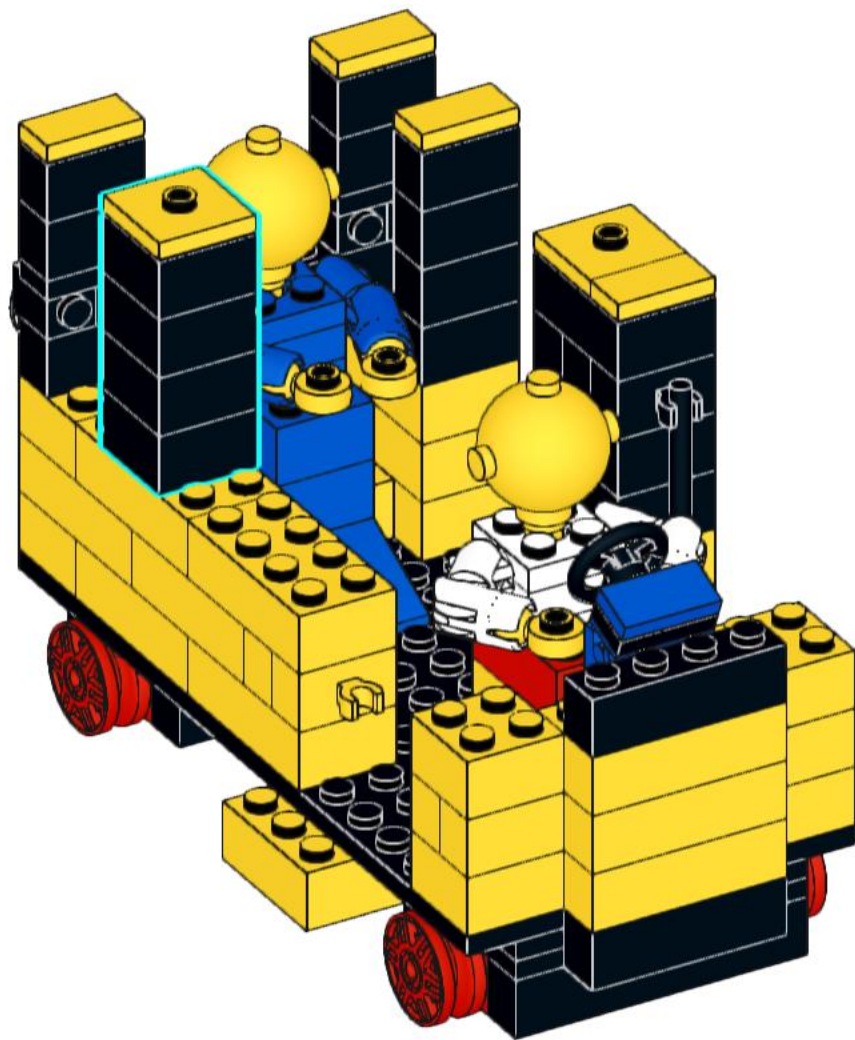
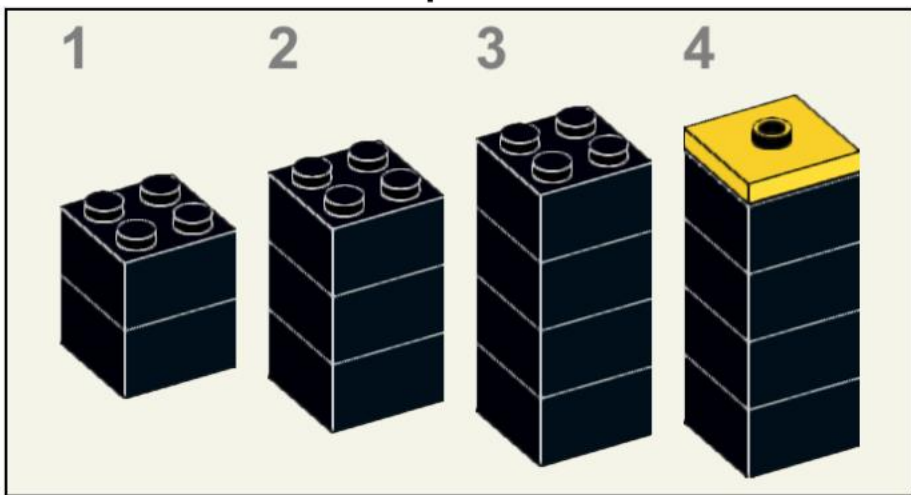
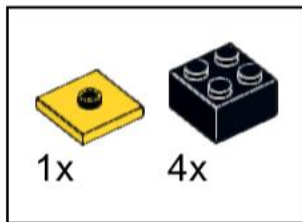

# 52

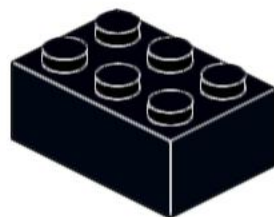
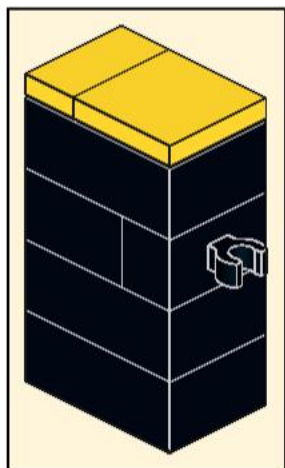
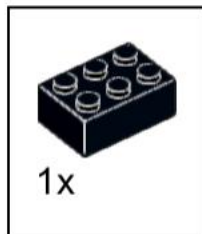

# 53

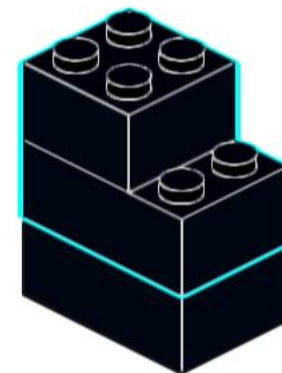
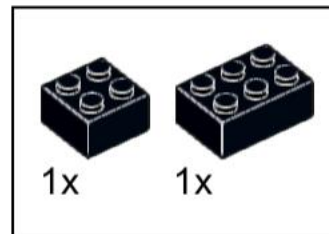

# 54

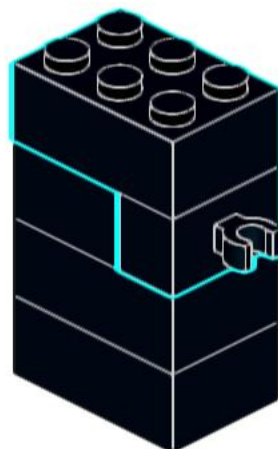
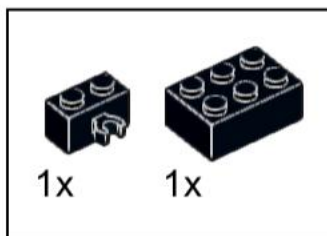

# 55

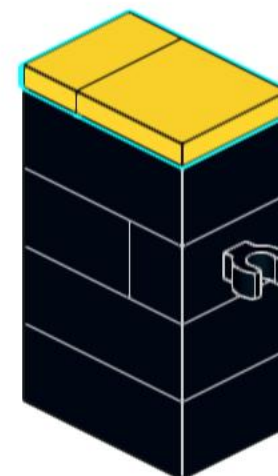
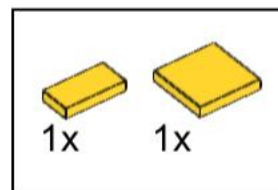

56

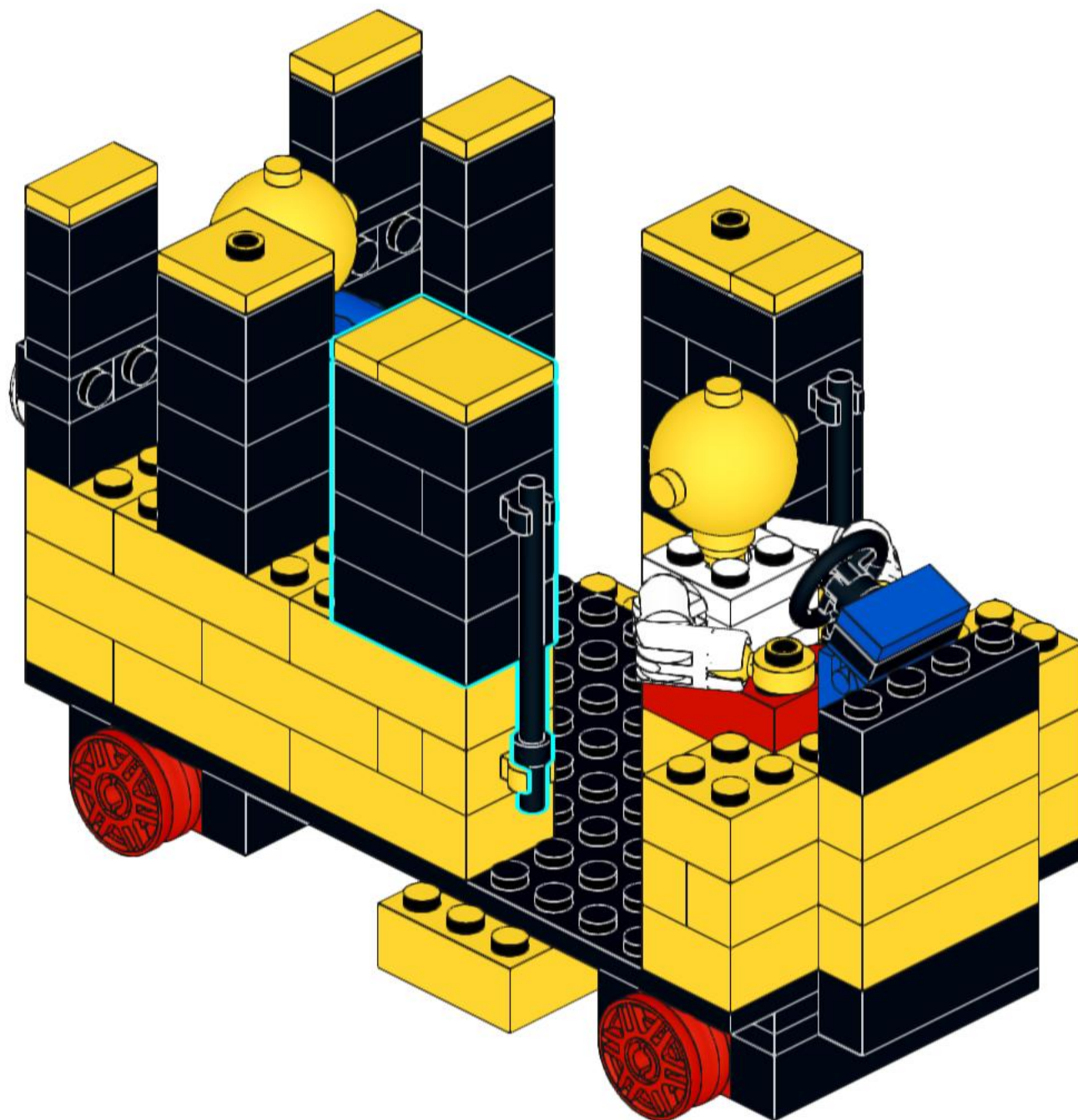

# 57

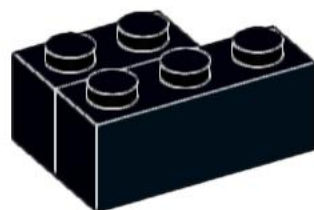
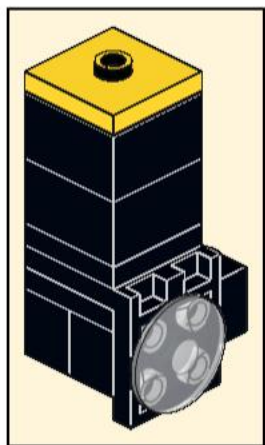
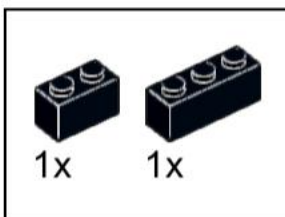

# 58

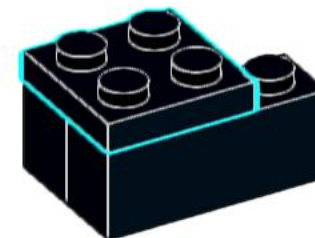
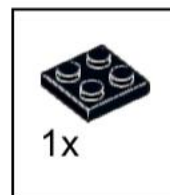

# 59

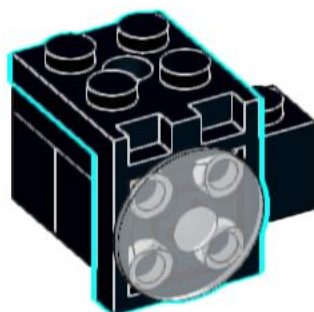
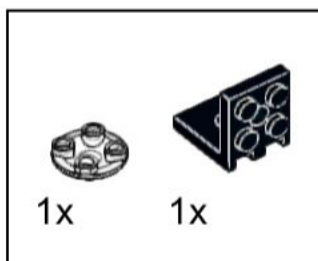

# 60

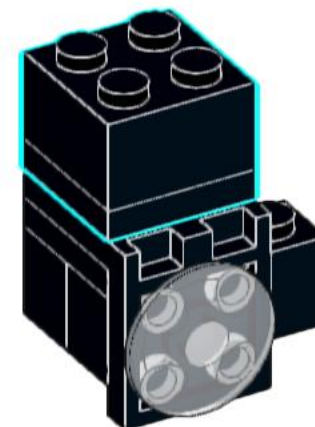
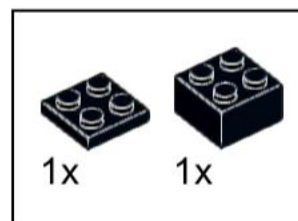

# 61

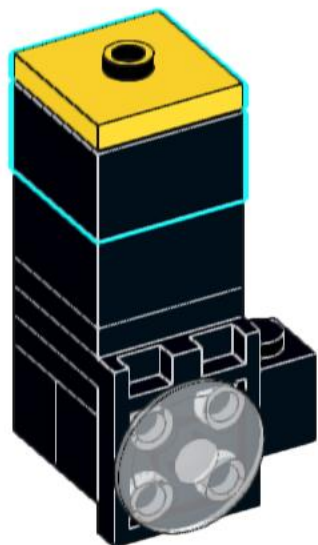
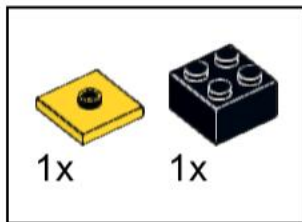

# 62

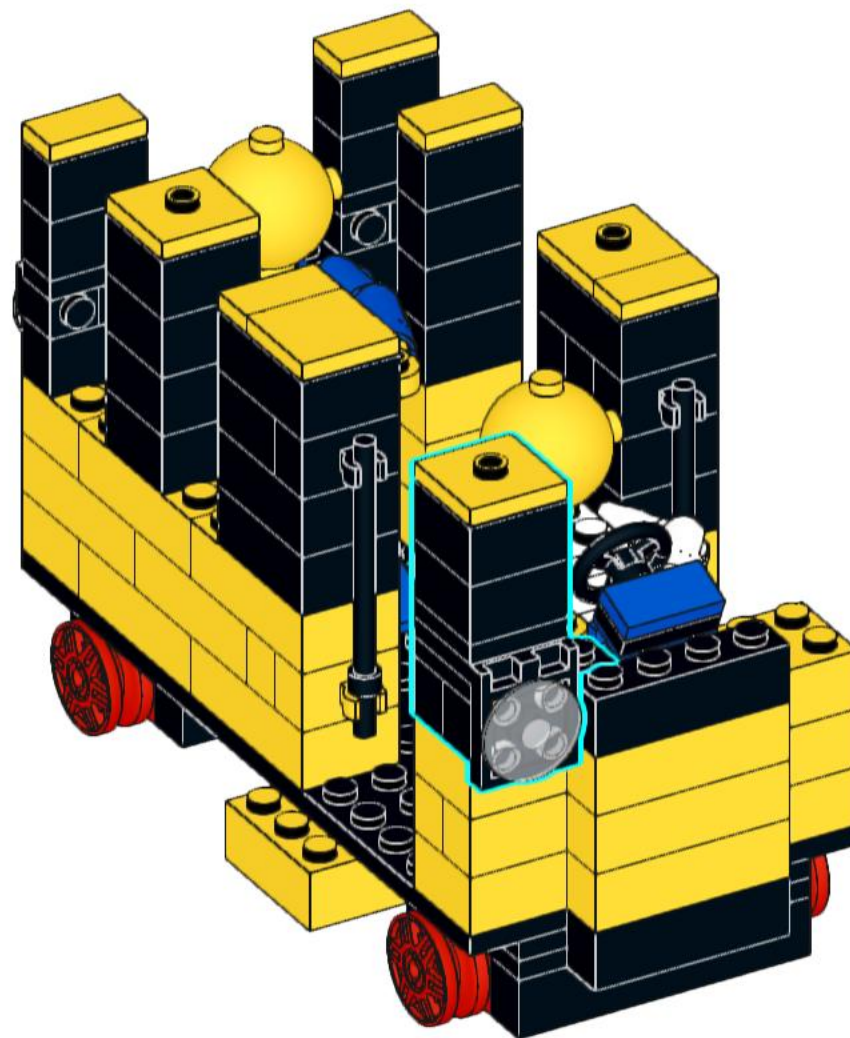

# 63

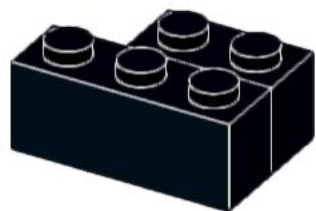
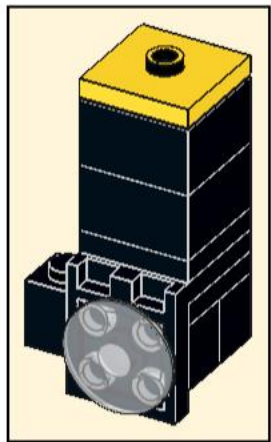
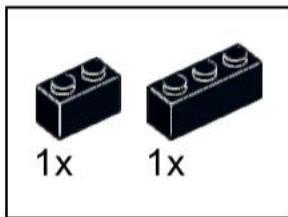

# 64

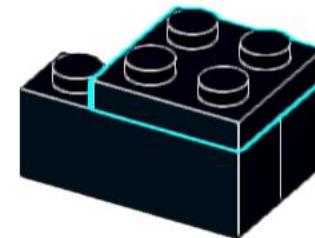
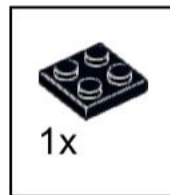

# 65

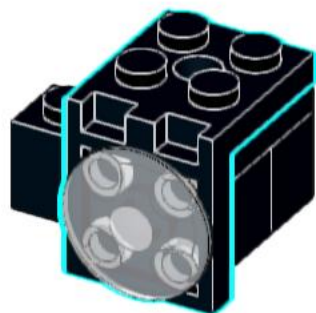
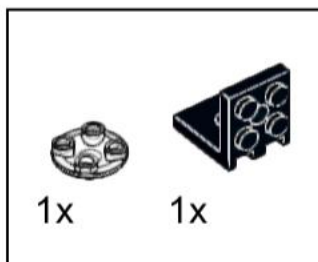

# 66

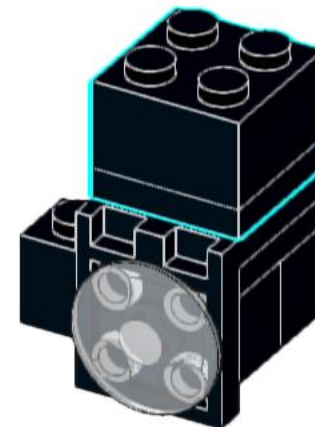
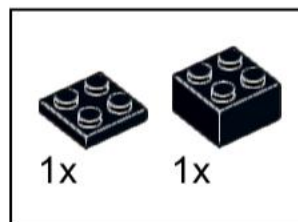

67

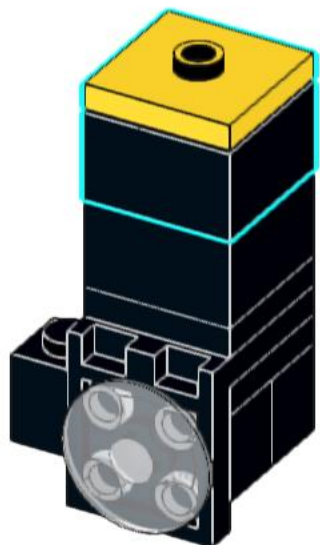
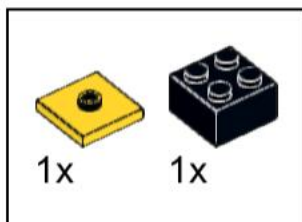

68

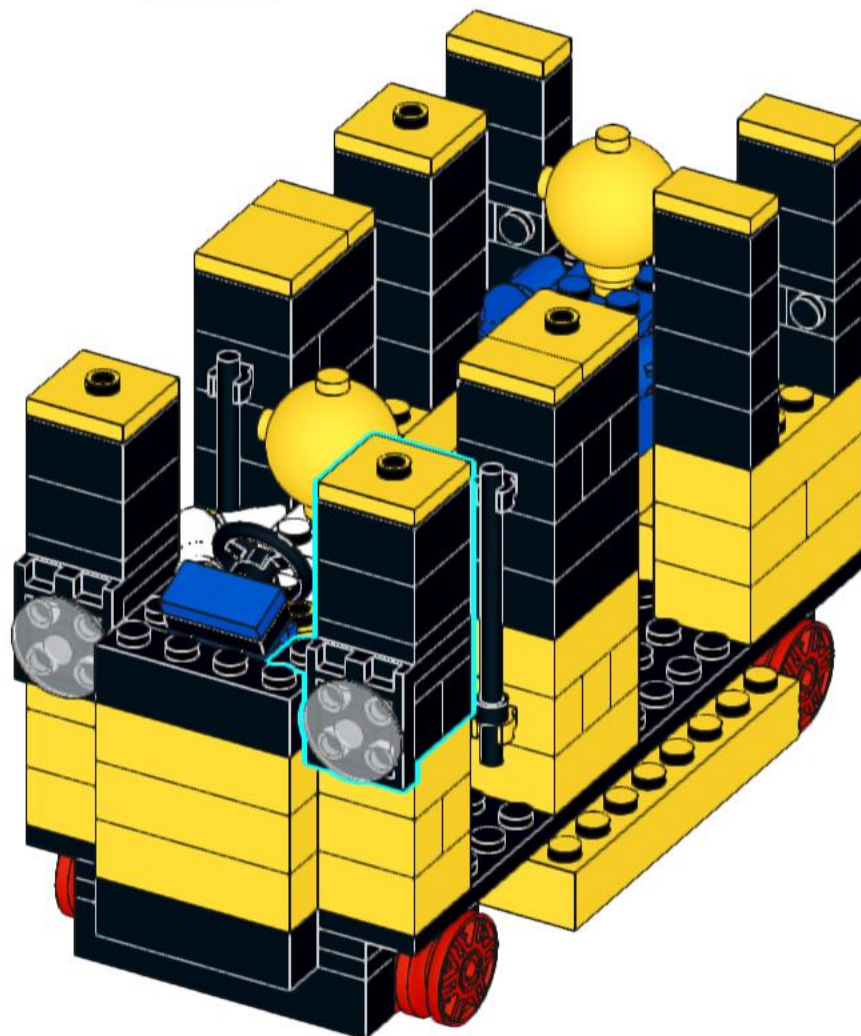

69

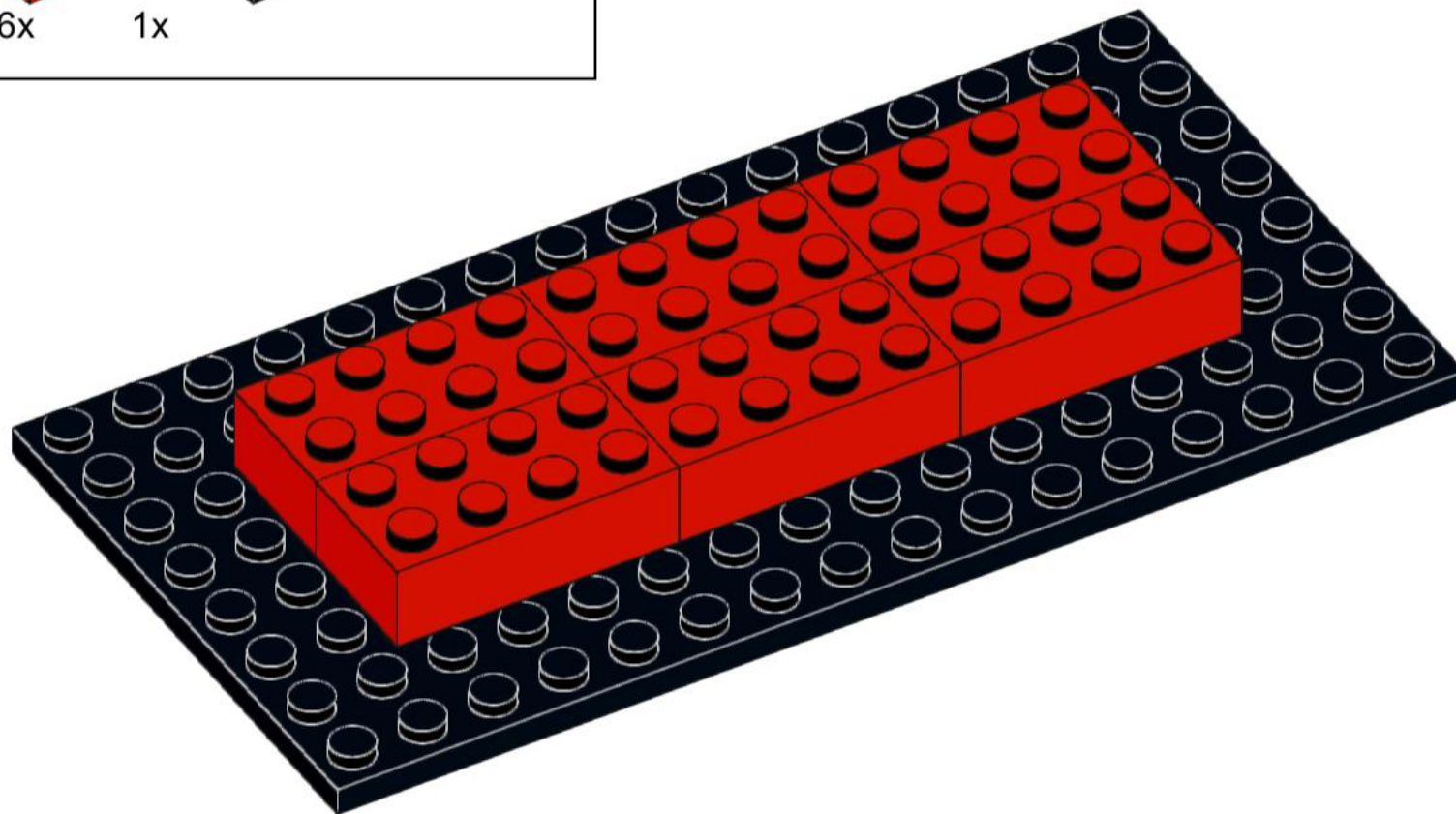
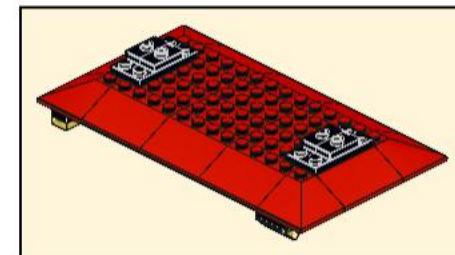
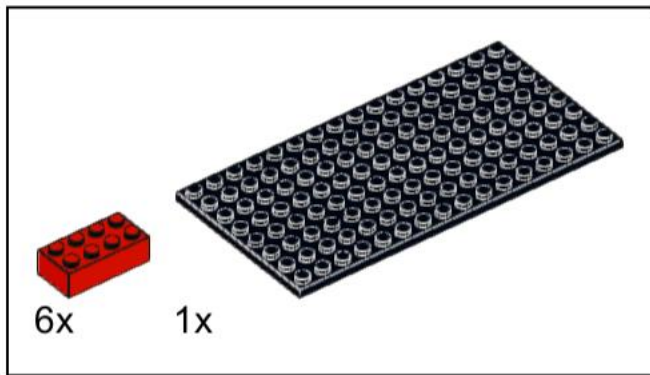



70

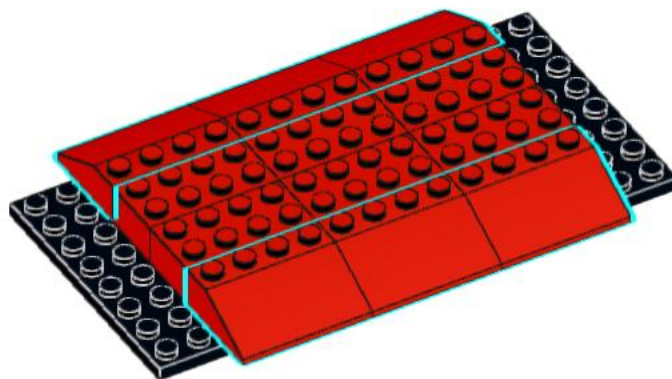
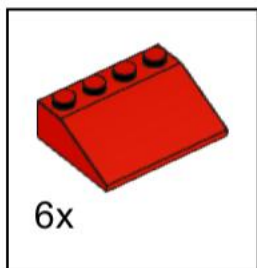

71

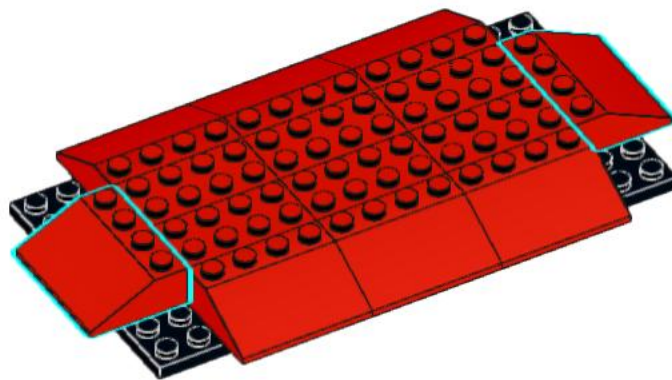
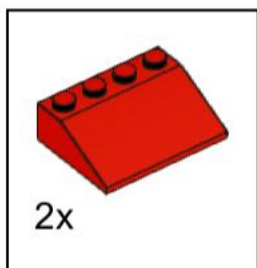

72

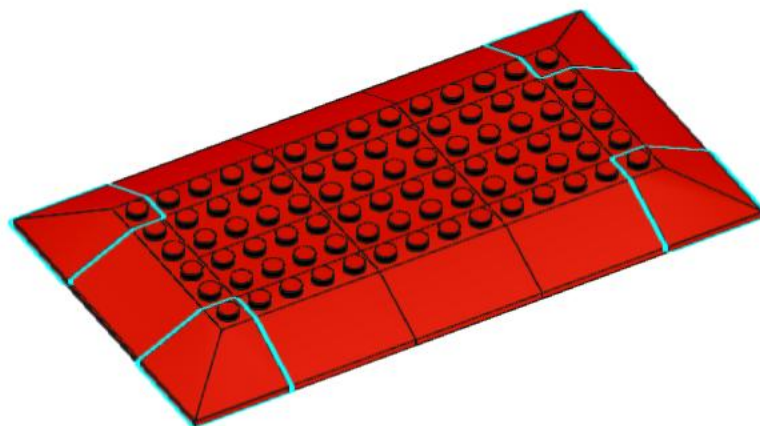
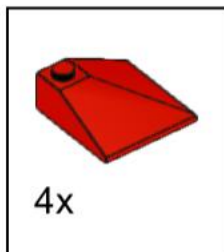

73

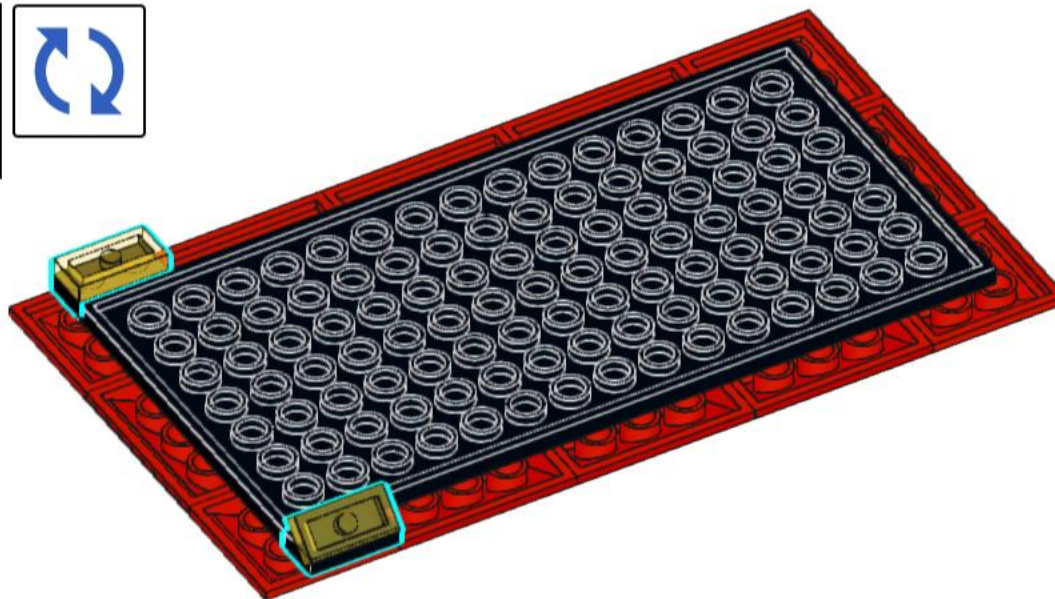
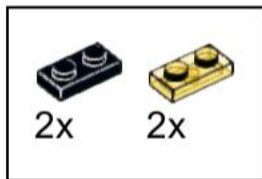

74

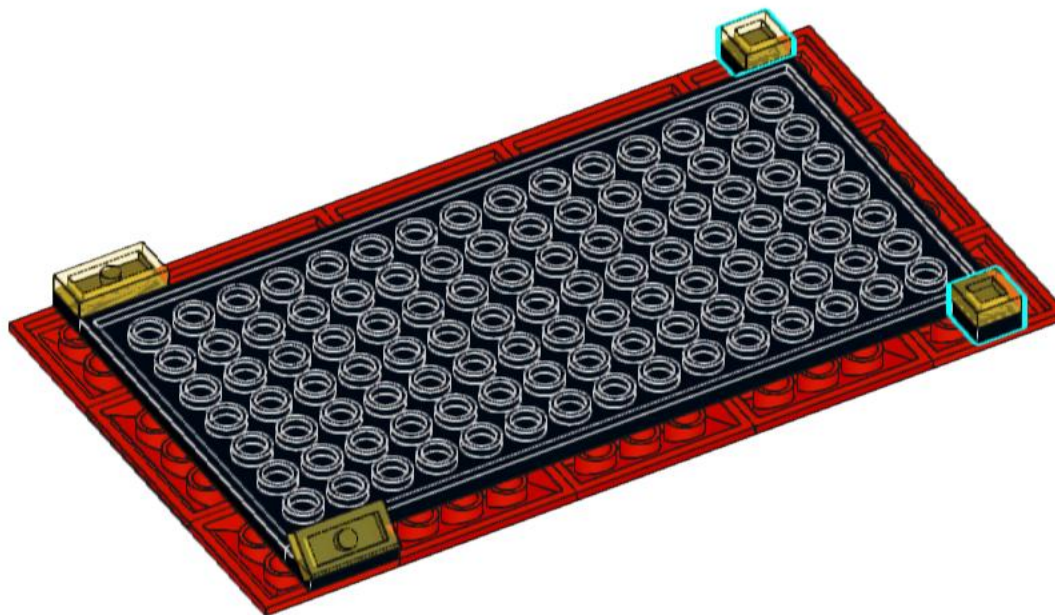
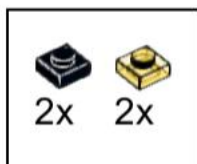

# 75

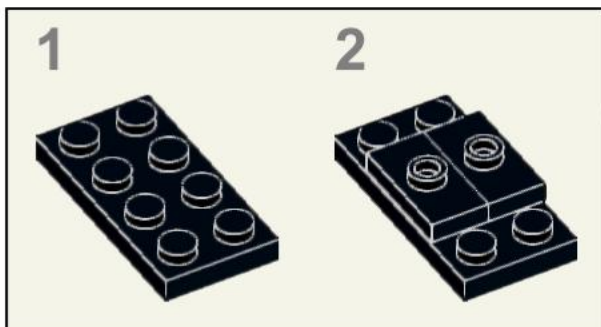

**2x**

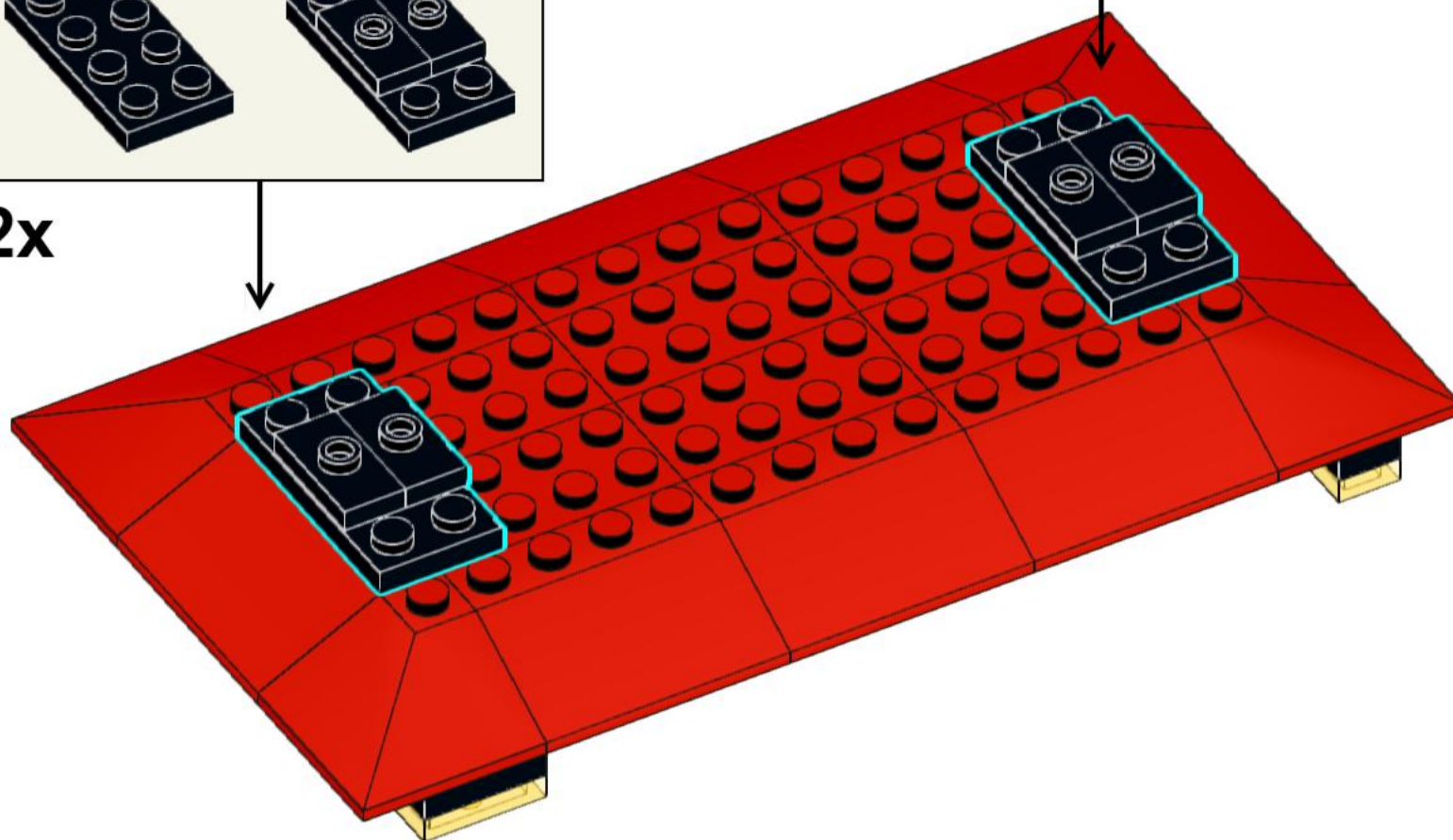

76

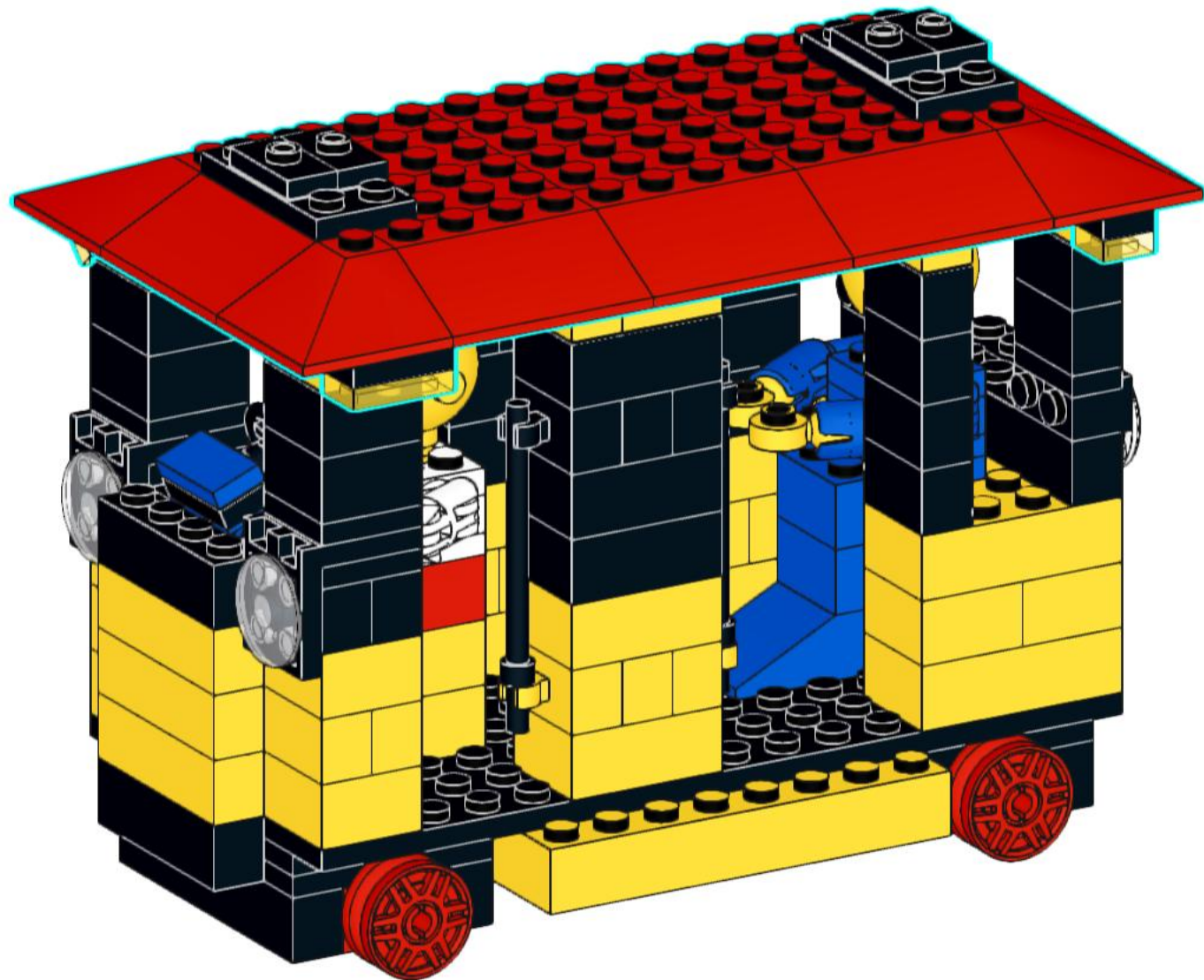

77

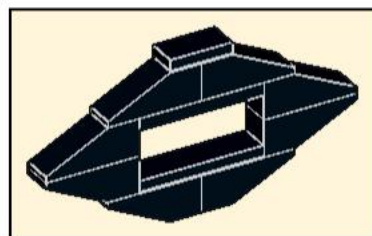
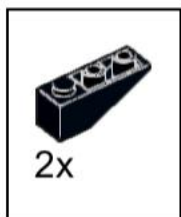

2x

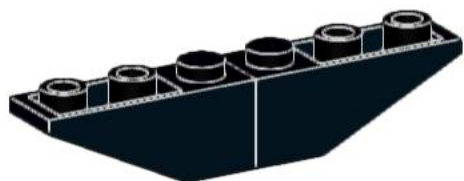

78

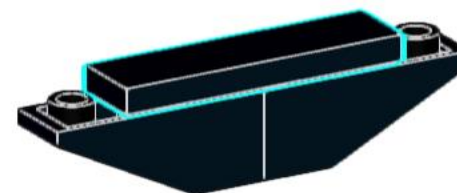
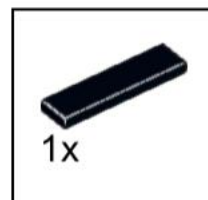

79

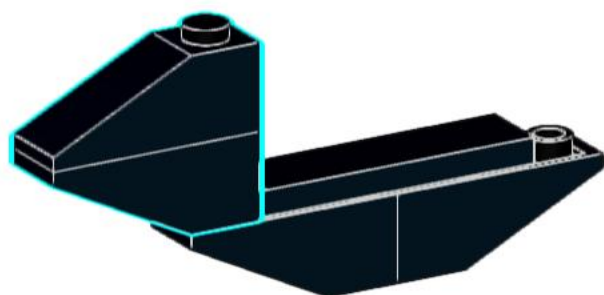
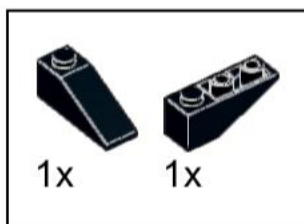

80

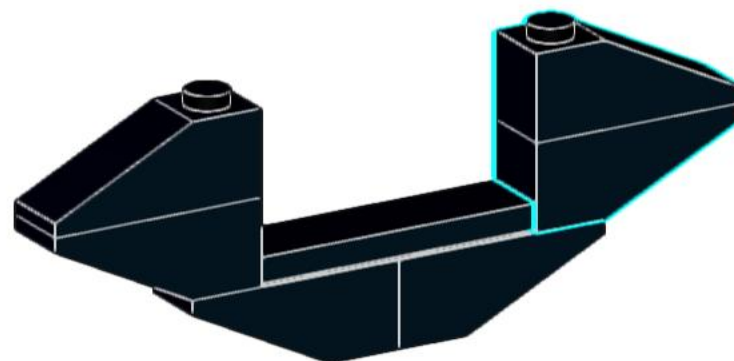
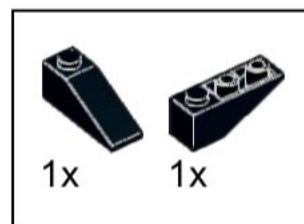

# 81

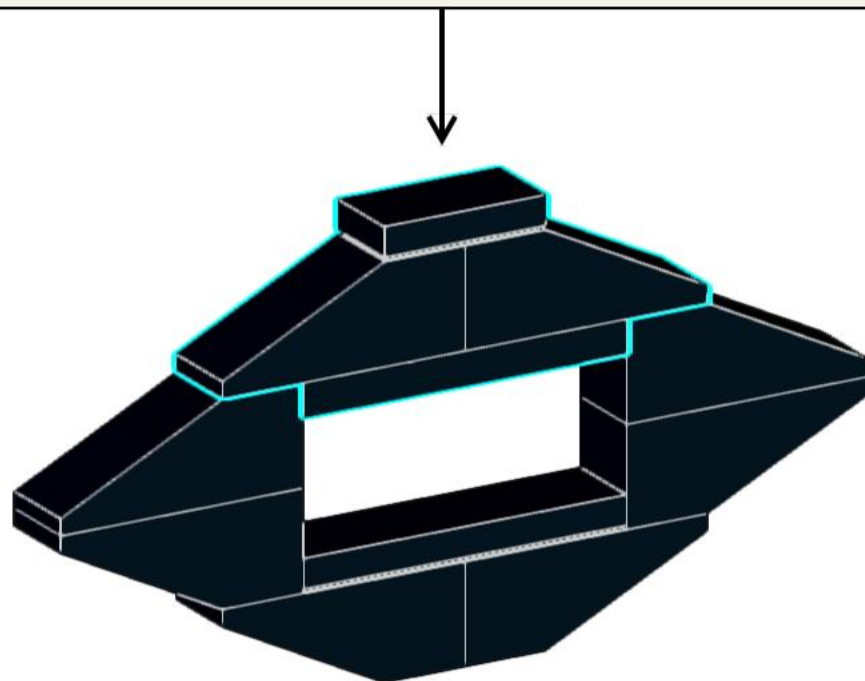
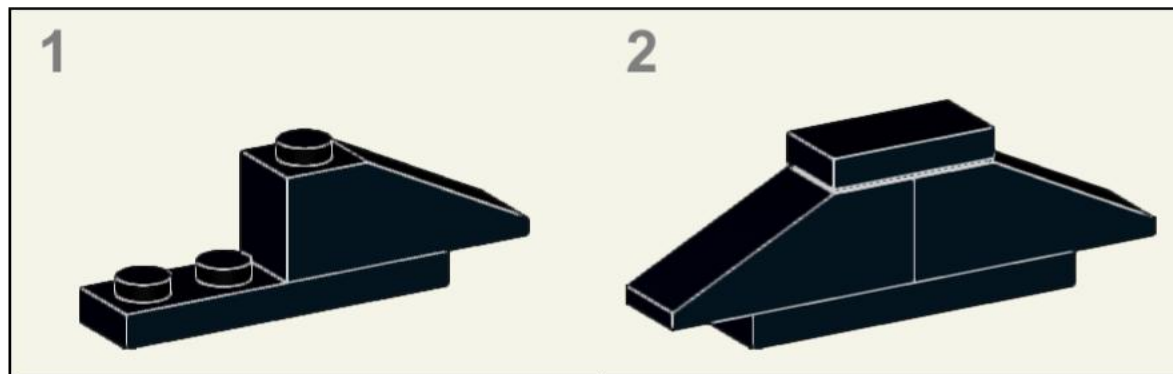
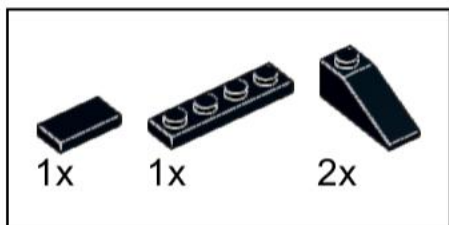

82

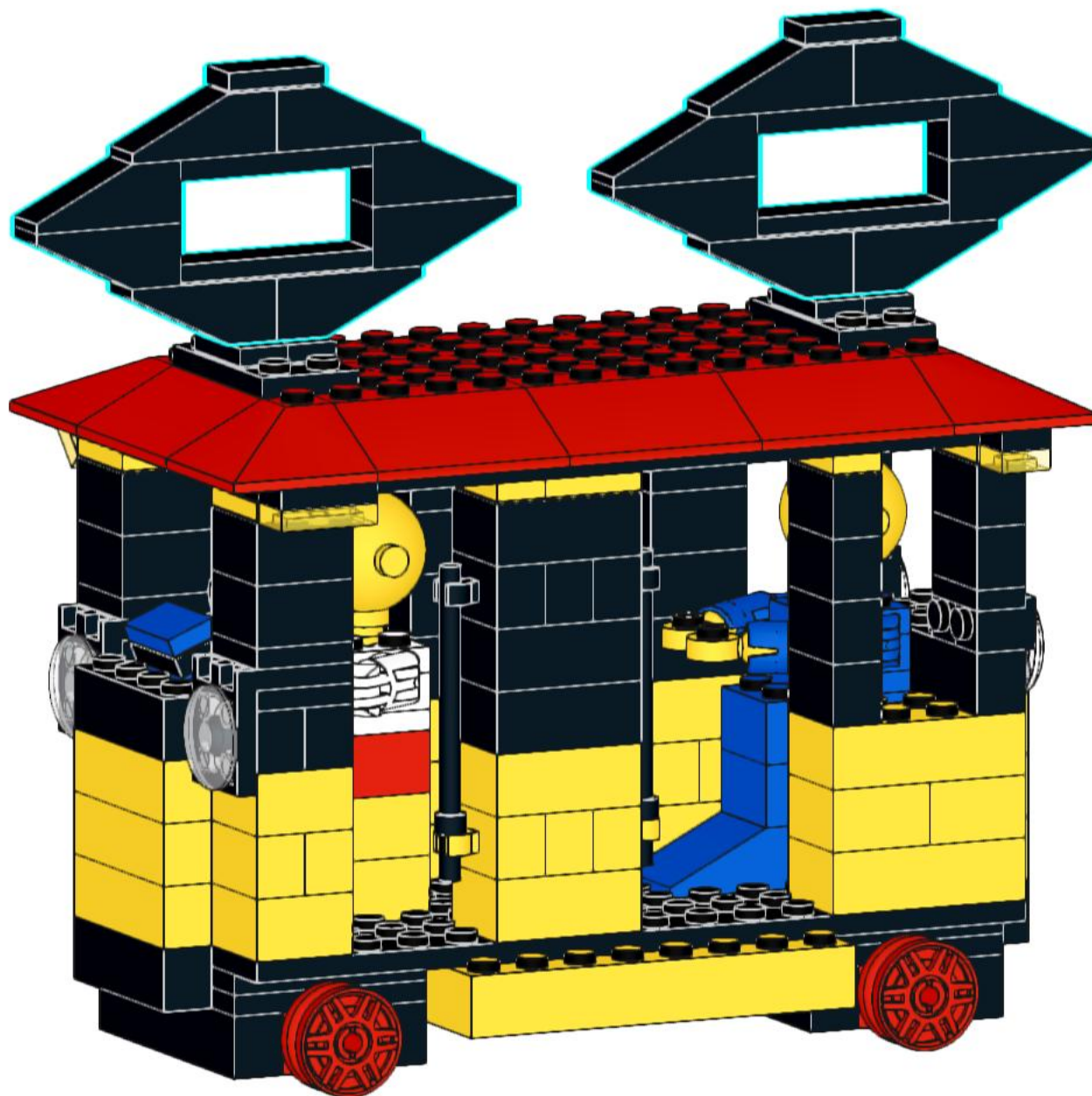







# Save a Brick

giving used bricks a new chance

Share your experience

Did you enjoy building this MOC?  
Let us know!

Share your build with us?  
Send us a photo of the MOC in action.

✉ [assemblytimes@save-a-brick.com](mailto:assemblytimes@save-a-brick.com)

Stay in touch

[www.save-a-brick.com](http://www.save-a-brick.com)

[instagram.com/sleepswithlego](https://www.instagram.com/sleepswithlego)

[facebook.com/SaveAnotherBrick](https://www.facebook.com/SaveAnotherBrick)

[pinterest.com/saveabrick](https://www.pinterest.com/saveabrick)