

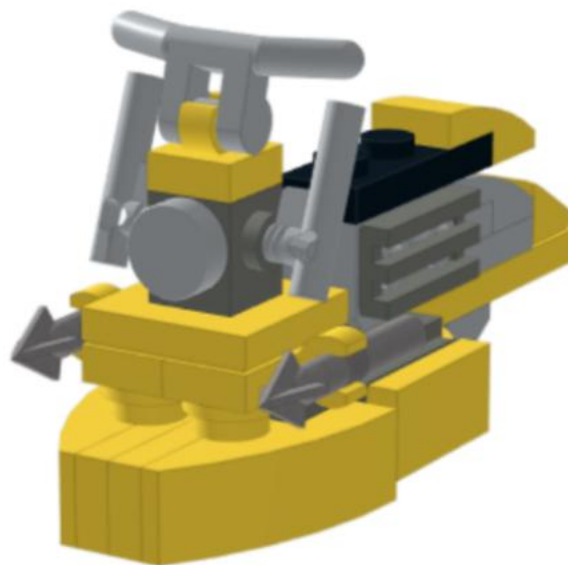

2022001

Speeder Bike

yellow



1

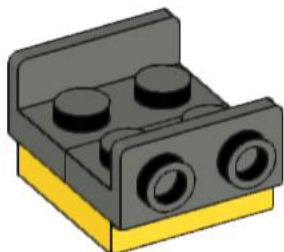
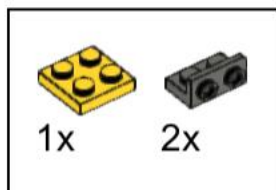

2

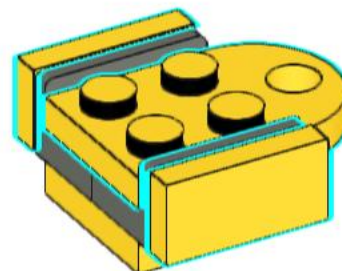
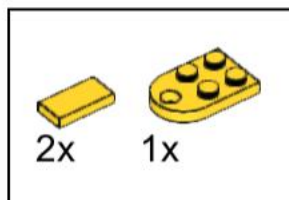

3

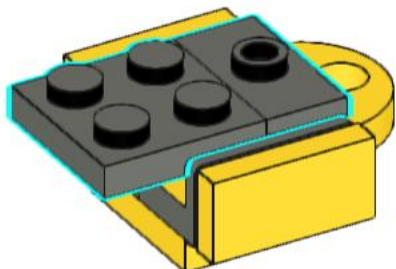
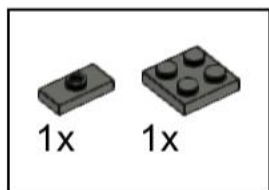

4

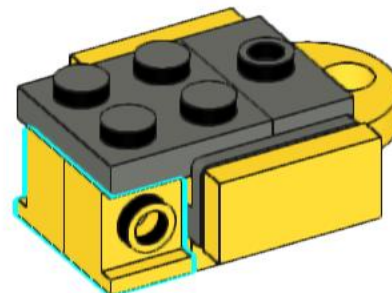
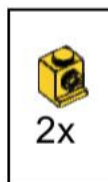

5

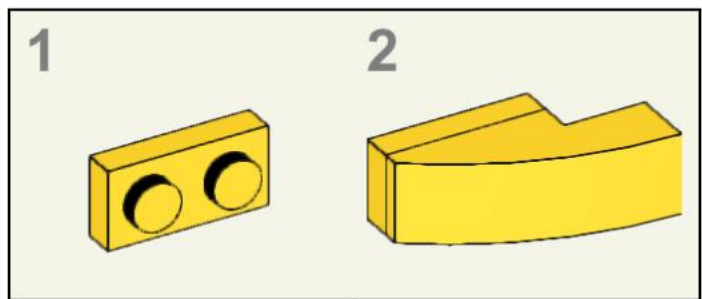
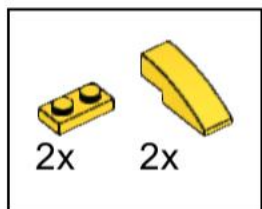

2x

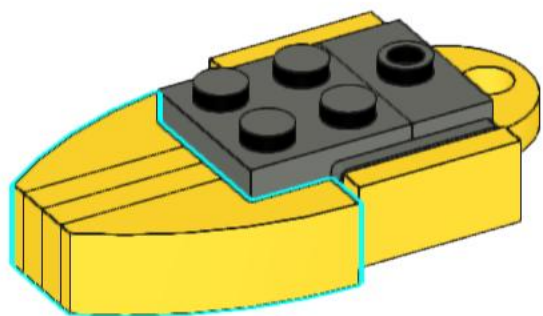

6

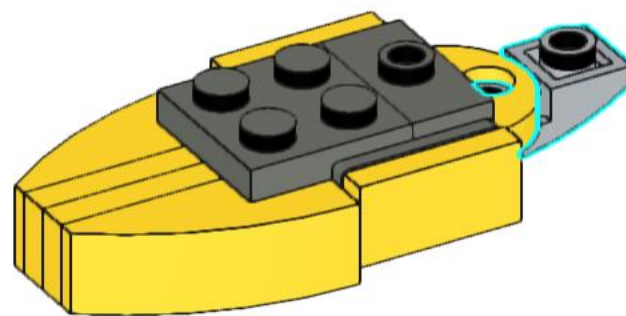
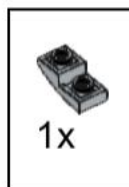

7

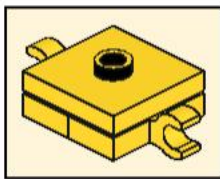
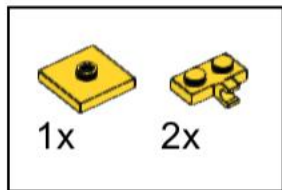

8

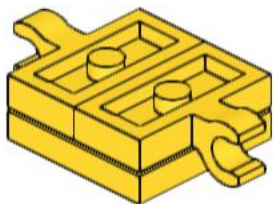

9

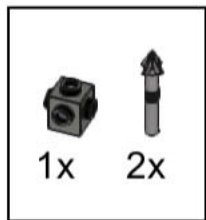

10

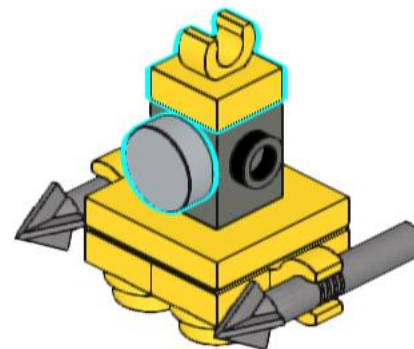
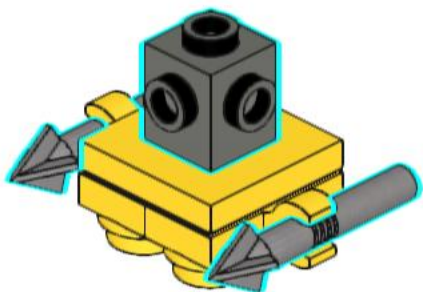
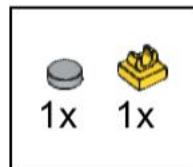

11

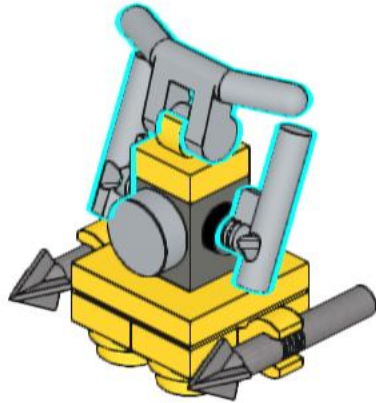
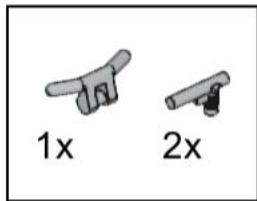

12

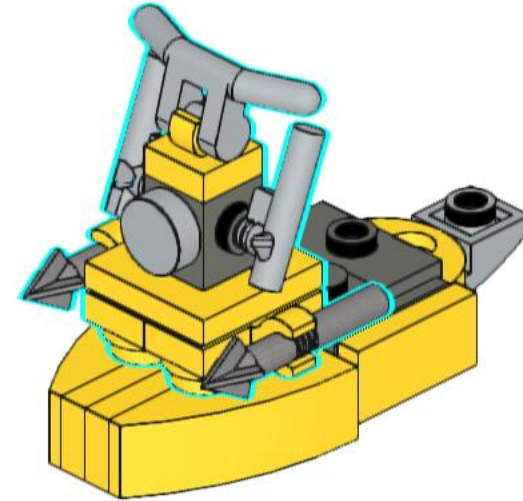

13

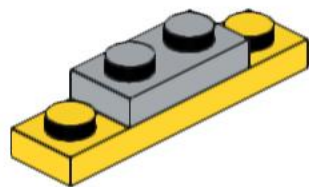
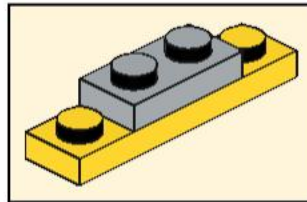
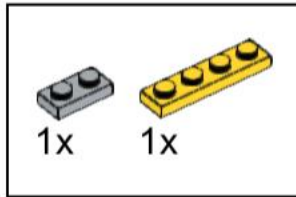

14

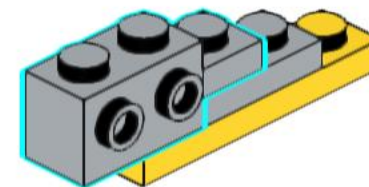
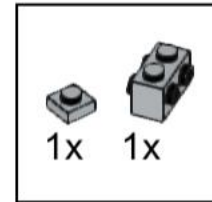

15

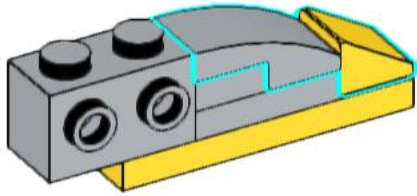
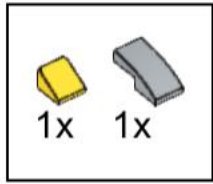

16

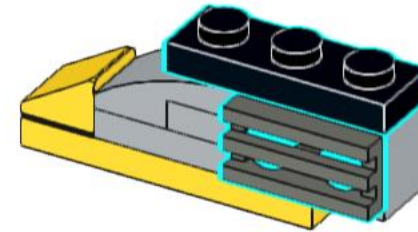
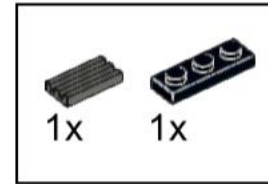

17

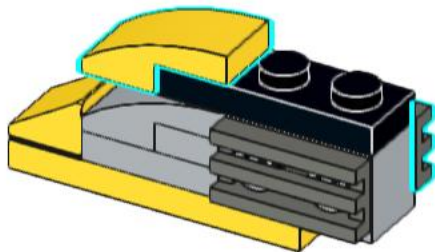
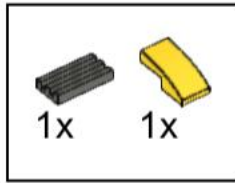

18

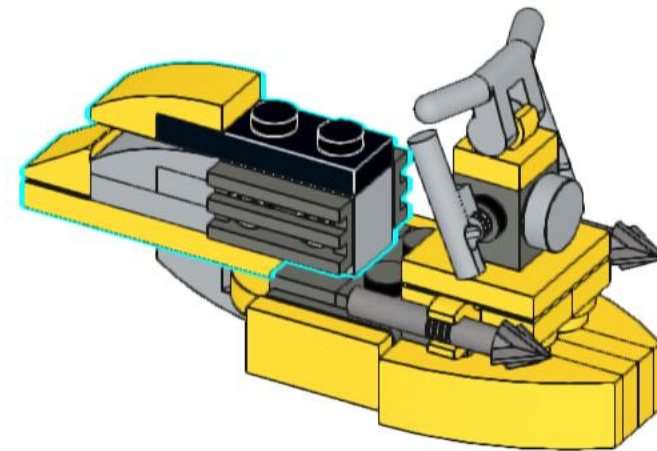



1x



1x

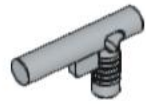

2x



2x

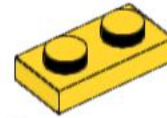

2x

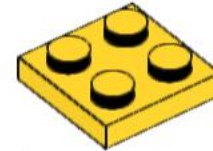

1x



2x



2x



1x

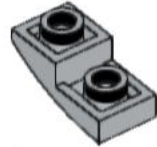

1x



1x

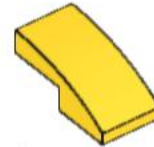

1x

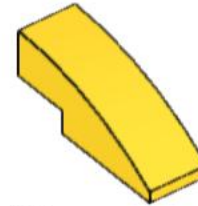

2x



1x



1x



1x

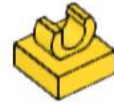

1x

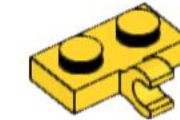

2x



1x



1x

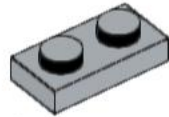

1x



2x

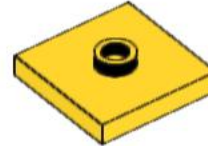

1x



2x

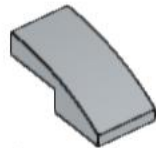

1x



1x

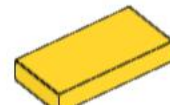

2x

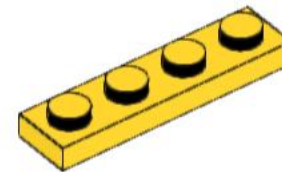

1x



Save a Brick

giving used bricks a new chance

Share your experience

Did you enjoy building this MOC?
Let us know!

Share your build with us?
Send us a photo of the MOC in action.

✉ assemblytimes@save-a-brick.com

Stay in touch

www.save-a-brick.com

[instagram.com/sleepswithlego](https://www.instagram.com/sleepswithlego)

[facebook.com/SaveAnotherBrick](https://www.facebook.com/SaveAnotherBrick)

[pinterest.com/saveabrick](https://www.pinterest.com/saveabrick)