

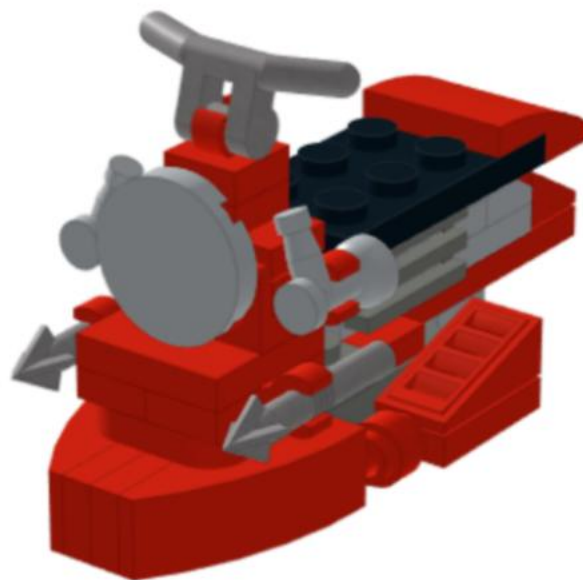

2022003

Speeder Bike

red



1

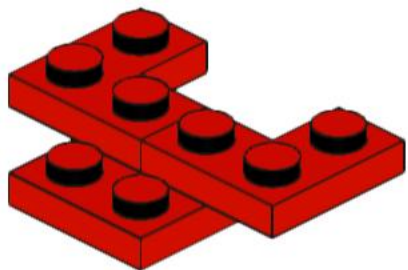
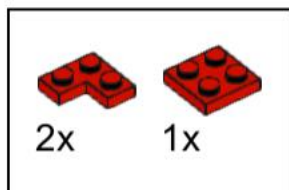

2

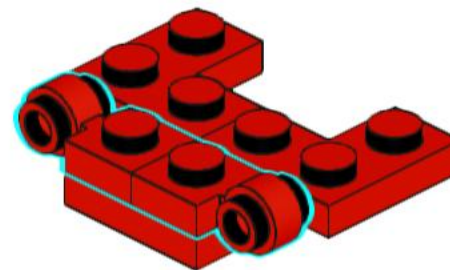

3

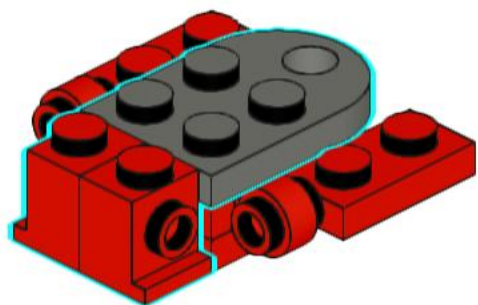
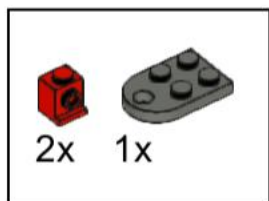

4

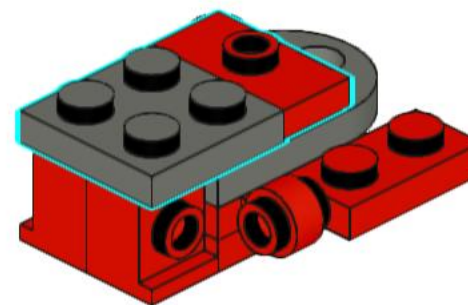
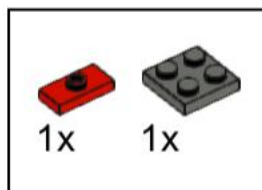

5

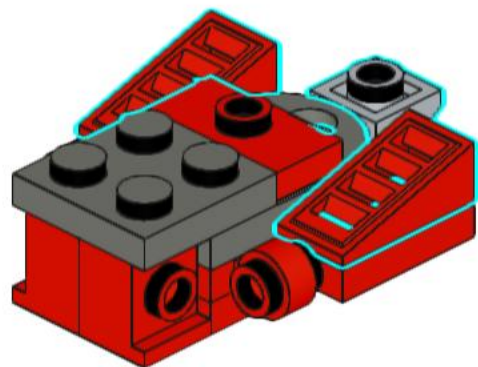
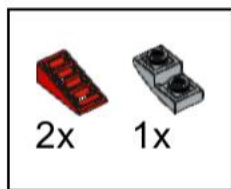

6

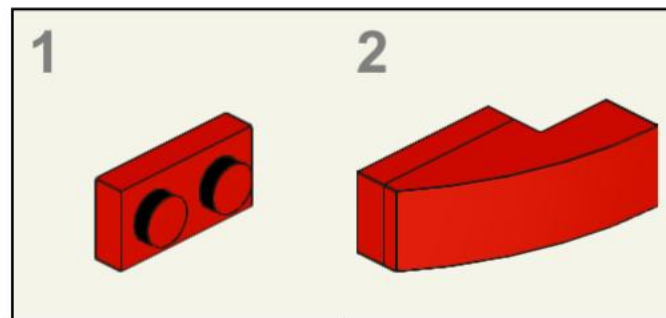
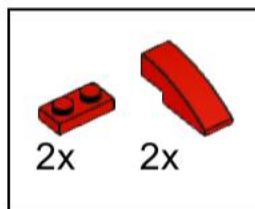

2x

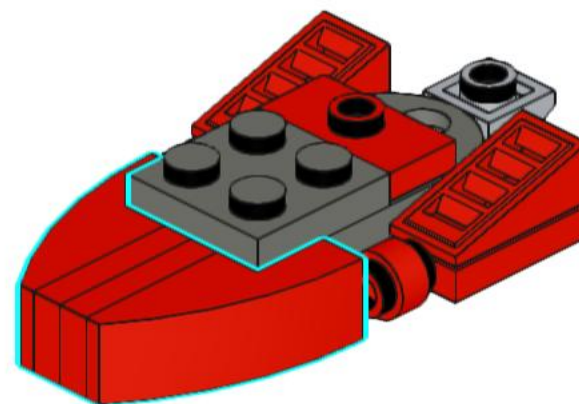

7

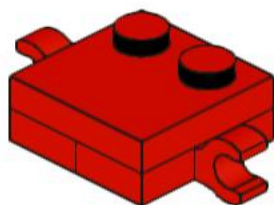
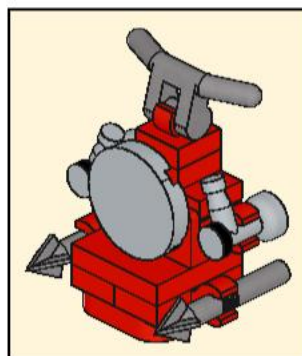
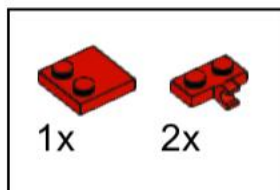

8

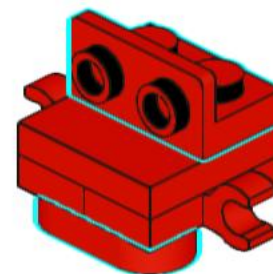
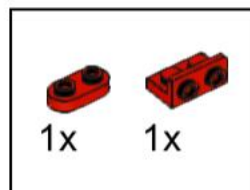

9

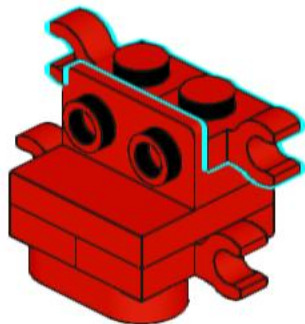
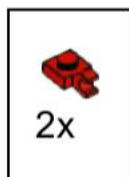

10

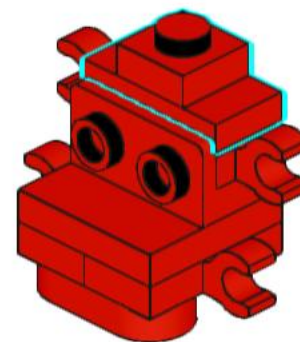
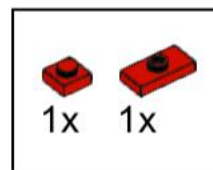

11

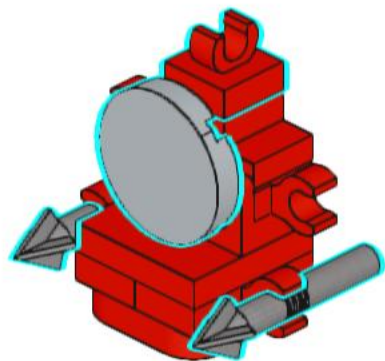
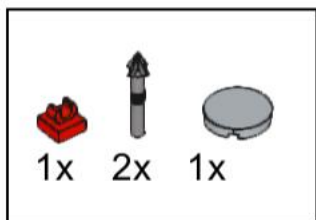

12

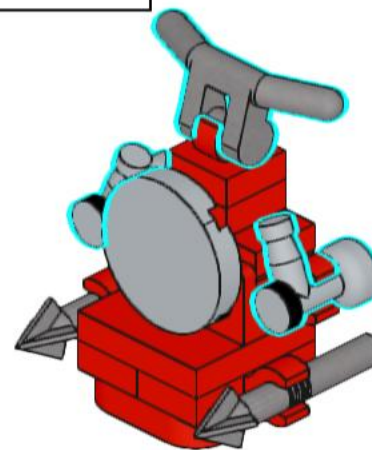
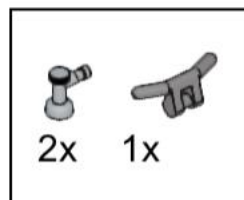

13

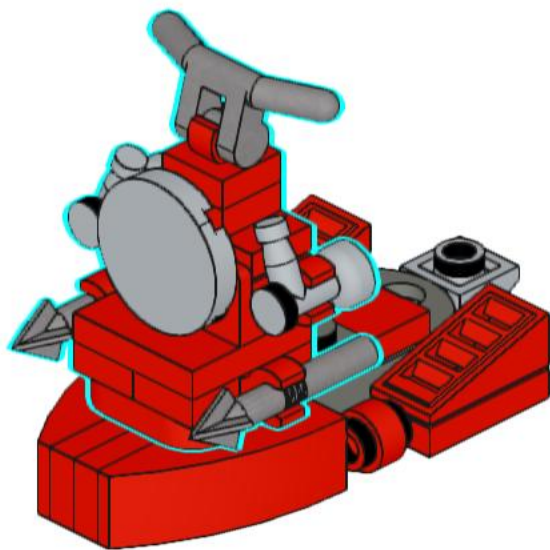

14

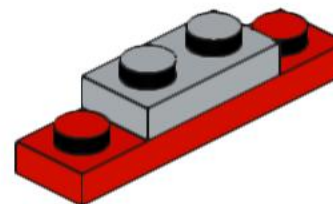
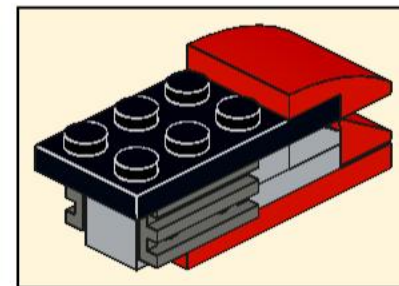
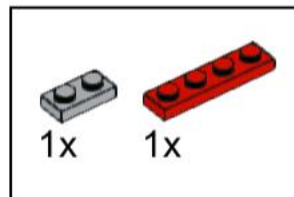

15

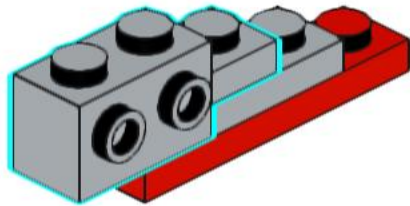
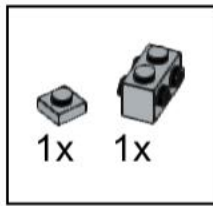

16

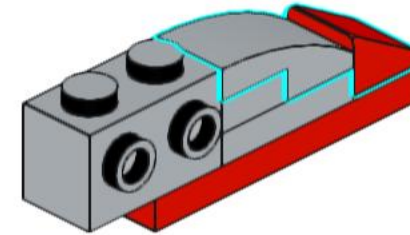
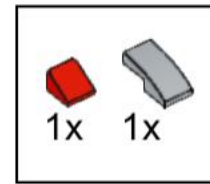

17

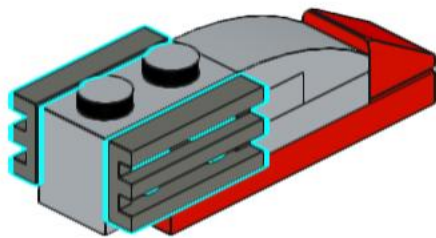
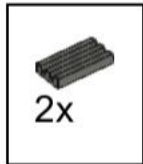



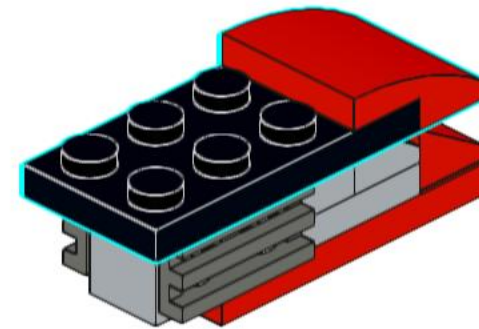
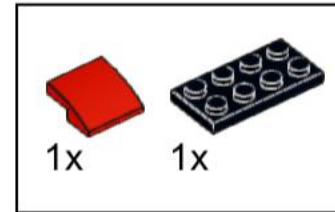



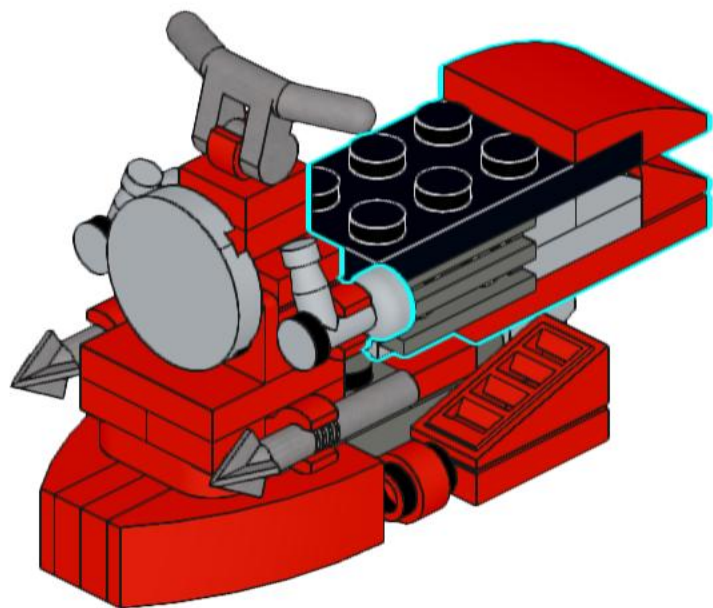









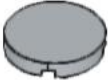













18



19



- | | | | |
|---|---|---|---|
| 
1x | 
1x | 
2x | 
1x |
| 
2x | 
1x | 
2x | 
2x |
| 
1x | 
1x | 
2x | 
1x |
| 
1x | 
1x | 
1x | 
2x |
| 
1x | 
1x | 
2x | 
1x |
| 
2x | 
1x | 
1x | 
1x |
| 
1x | 
2x | 
2x | 
2x |
| 
1x | 
2x | 
1x | 
1x |



Save a Brick

giving used bricks a new chance

Share your experience

Did you enjoy building this MOC?
Let us know!

Share your build with us?
Send us a photo of the MOC in action.

✉ assemblytimes@save-a-brick.com

Stay in touch

www.save-a-brick.com

[instagram.com/sleepswithlego](https://www.instagram.com/sleepswithlego)

[facebook.com/SaveAnotherBrick](https://www.facebook.com/SaveAnotherBrick)

[pinterest.com/saveabrick](https://www.pinterest.com/saveabrick)